

## Made in Bulgaria



What started with a trapezoid has become a portfolio, with a variety of modular school furniture. Years ago, we realized that teachers were hampered in their efforts to implement collaborative learning in the classroom. It was obvious that the classical tables could not be arranged in compact groups of four to eight students. The challenge was to create a range of mobile cluster tables offering flexibility and freedom in creating groups for teamwork or individual work. POLY table on page 26.

We have progressed beyond the main functionality in the grouping of student furniture. No one offers more options for choosing forms that allow grouping to work in small groups. All of these options are available in a variety of colors and decors. We have expanded the category to such an extent that you can choose the furniture on the basis of which to create an aesthetic and harmonious atmosphere in the classroom.



We have developed an innovative concept for children's modular cabinets and shelves. We created a design with a safety rounding of the external front details and removed the protruding handles. We designed bulky drawers with wheels for full pull-out and free movement in the whole room, on page 54. We also developed a series of children's tables and chairs in the same style, allowing creative design of beautiful playgrounds. We also added cabinets with plastic containers.

When it comes to how to furnish the office, take a look at our modular desk systems. Elegant solutions with metal legs and various complementary elements, creating an individual look and atmosphere in the workplace. Meeting tables, various shelves and cabinets for documents. Functionality in the furniture, combined with modern style and creative approach. Page 62.



# Content

<b>FOR MEBEL FACTOR</b>	<b>4</b>
Ergonomic norms and standards for children's furniture	5
<b>SCHOOL FURNITURE</b>	<b>6</b>
School furniture	6
Single school tables	12
Double school tables	18
Triple school tables	23
Modular school tables	24
Single combo desks	30
Double combo desks	31
Computer and specialized tables	32
Student cupboards and shelves	34
Teacher cabinets	35
<b>SPECIALIZED FURNITURE</b>	<b>38</b>
Whiteboards, cork boards and flipcharts	36
Shelves and trolleys Callero GRATNELLS	38
Trays and inserts GRATNELLS	40
Mobile shelves with GRATNELLS trays	41
Shelves and cabinets with GRATNELLS trays	42
<b>KINDERGARTEN FURNITURE</b>	<b>44</b>
Kids chairs	44
Kids modular and dining tables	46
Kids furniture series HAPPY	49
Benches with backrest and without backrest	50
Kids modular furniture with secure corners	52
Wardrobes for kindergartens	54
Beds for kindergartens	55
<b>HOUSEHOLD FURNITURE</b>	<b>56</b>
Dining tables	56
Chairs, stools and bar stools	58
Hangers and wardrobes	60
<b>OFFICE FURNITURE</b>	<b>62</b>
Modular office desks	62
Office containers and accessories	65
COMPACT and TINA desks	66
COMPACT and TINA computer desks	67
Conference and meeting tables	68
Office shelves and cabinets	70
Manager and work chairs	72
Shelving system SMART	74
<b>FURNITURE COMPONENTS AND SPARE PARTS</b>	<b>78</b>
<b>CARTELS WITH COLORS AND DECORS</b>	<b>80</b>

Mebeli B&B Ltd. is a productive company with an active position on the Bulgarian market. The company is using the trade mark Mebel Factor, created in 1998. Initially, the company established an installation for electrostatic powder coating and worked in the service sector. Following the pre-development objectives a production of tubular furniture was organized at the beginning of 1999.

According to the dynamic development of the market conditions in Bulgaria, the company develops and manufactures nomenclature of chairs and tables for different purposes. The firm follows to the current norms and standards in the furniture industry in particular standards for furnishing of schools, kindergartens and other public institutions. All products have a contemporary and modern outlook as well as functionality. The company can be distinguished by professionalism, innovation, teamwork, respect for the customer, quality products and reasonable prices.

Highly qualified staff works in Mebeli B&B Ltd. In the process of the development of the company, we have created a system of in house training and adopting new technology. Through the years our team has become an effective structure of motivated workers, able to respond flexibly to any problem. Company staff, as well as the specialized, highly productive equipment are the guarantee for a flexible response to market changes and excellent co-operation with many partners. Currently the company has employed 24 people, 20 of which are workforce. Activities take place in our own base with total area of 3500m<sup>2</sup>, of which 1500m<sup>2</sup> are manufacturing area.



Design, production and delivery of:

- furniture for schools and educational institutions
- furniture for kindergartens and children centers
- metal frame furniture
- metal household furniture
- furniture for public establishments
- office furniture
- specialized library furniture
- commercial furniture
- production of metal structures
- component metal parts
- tubular furniture frames
- bending of metal pipes and profiles
- electrostatic powder coating
- specialized wire products



Children are the most important part of a society. That is why we, the adults, need to concentrate our efforts on their growth as healthy and fulfilled people. A main part of them growing up is the healthy development of the musculoskeletal apparatus. A correct posture means a strong and healthy spine. A child having a good posture and a strong body in the future is determined by how the youngster sits and positions himself every day in school. The posture is directly linked to an individual's self-esteem and their well-being in the future. Good physical development guarantees a good foundation for an individual's mental and bodily health.

School furnishing is often underestimated as a major factor in a child's growth. We, at "Mebel Factor", support the thesis that it is not correct for the furnishing in schools to aid the emergence of spinal distortions in kids. We support the claim that the decision for school furnishing should be done in a really careful fashion.

The spine has not finished its development at this young age, this is meant to happen when the youngster is 18-19 years old. Children spend many hours sat down on a table during school or home whilst learning and writing their homework. This makes the decision of the suitable furniture exceptionally important.

A primary principle that could guarantee this is the adequate height of the furnishing. The height should be determined by the age of the child. It is of utmost importance that the child, whilst sat down, has its feet firmly on the ground, while its knees form a right angle. Secondly, the torso and the hips need to form a second right angle. This is the so called "correct sitting posture". The compliance with these requirements would prove to be detrimental towards the protection of the child from scoliosis. When it comes to the desk or table, it needs to be at the least 70cm by 50cm. This is needed because the workspace needs to fit all needed supplies, as well as have space for the child to put its elbows on the edges of the desk or table.

The other "enemy" of a child's health, nearsightedness, should not be underestimated. Nearsightedness (or myopia) is a condition where objects near can be seen clearly but objects farther away can be blurry. In order to protect a child from this condition, they need to keep the so called "optical hygiene". This means that the child needs to have a distance between its eyes and the books placed on a desk, no less than 35cm, good lighting and a rest every 40 minutes.

If all of these conditions are taken into account, the body posture would be correct, the back will not be in a bad stance, which, on its own, would lead to a healthy physical development of the child's body.

"Mebel Factor" offers safe, rounded edges for its school tables and appropriate chairs, with a suitable height, taking into account the age of a child. The height of the desks and chairs are determined by the BS EN 1729 standard and are based on ergonomic research for children from the whole European Union. The dimensions are changed periodically due to the acceleration of growth in different generations.

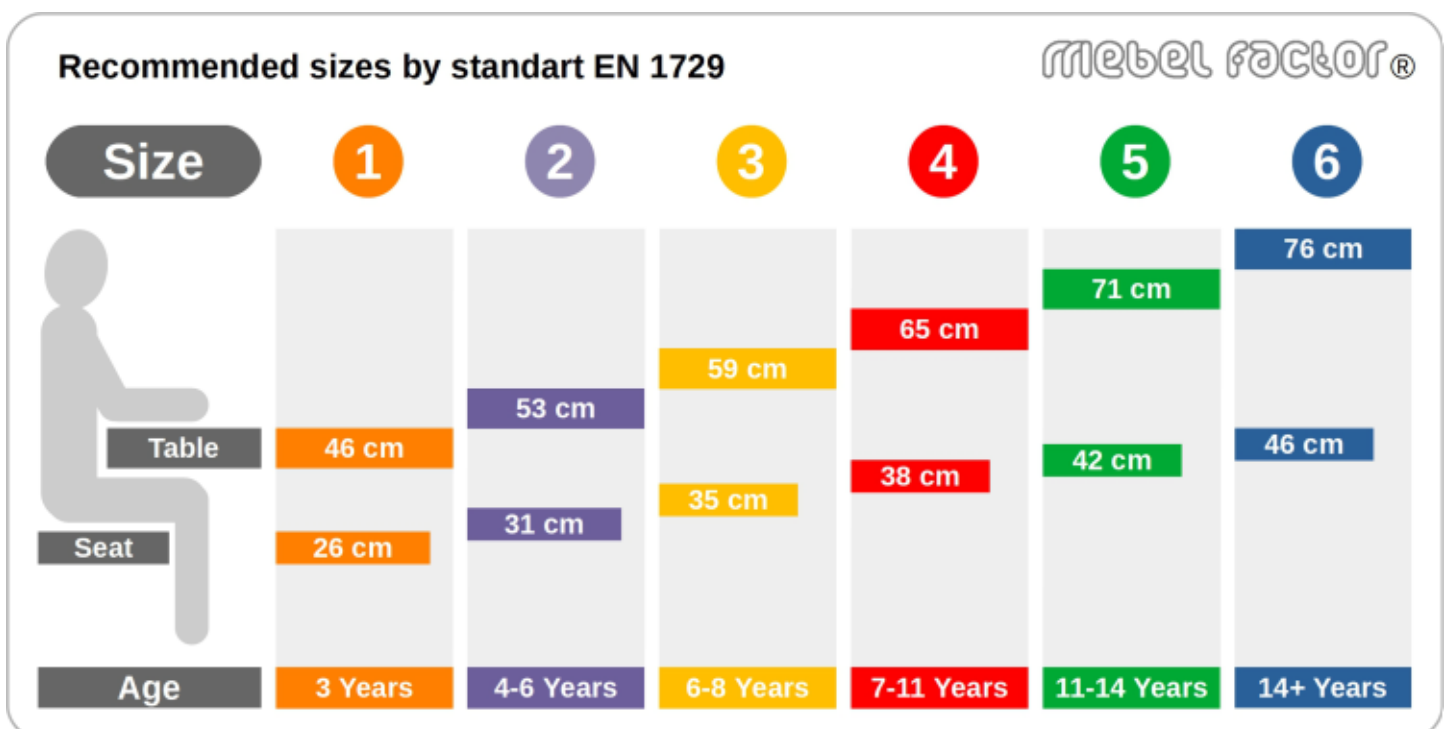



## Chair PICO

School chair with reinforced, metal frame.  
Suitable for high-intensity study halls.

Maximum weight of the seated 150kg.  
Steel frame made of 25mm tube.  
Polymer powder coating in RAL colours.  
Seat and backrest made of 7mm beech plywood.  
Durable plastic glide plugs.  
Stackable up to 7 pieces.  
Made in Bulgaria.  
The product complies with EN 1729 standart.

Article No	Seat size	Size
112 800007	H 50cm, 40x41cm, Size 7	48x54/88cm
112 800006	H 46cm, 40x41cm, Size 6	47x53/83cm
112 800005	H 42cm, 35x36cm, Size 5	44x46/76cm
112 800004	H 38cm, 35x36cm, Size 4	44x45/70cm



## Chair PICO upholstered

School chair with reinforced, metal frame.  
Suitable for high-intensity study halls.

Maximum weight of the seated 150kg.  
Steel frame made of 25mm tube.  
Polymer powder coating in RAL colours.  
Upholstered seat and backrest made of 7mm plywood.  
Durable plastic glide plugs.  
Stackable up to 7 pieces.  
Made in Bulgaria.  
The product complies with EN 1729 standart.

Article No	Seat size	Size
112 800027	H 50cm, 40x41cm, Size 7	48x54/88cm
112 800026	H 46cm, 40x41cm, Size 6	47x53/83cm
112 800025	H 42cm, 35x36cm, Size 5	44x46/76cm
112 800024	H 38cm, 35x36cm, Size 4	44x45/70cm



## Chair ERGO

School chair with metal legs and polyurethane monoblock in several colors. Allows sitting in both directions. Resistant to cleaning with water.

Maximum weight of the seated 150kg.  
Steel frame made of 25mm tube.  
Polymer powder coating in RAL colours.  
Polyurethane seatshell.  
Durable plastic glide plugs.  
Stackable up to 5 pieces.  
Made in Bulgaria.  
The product complies with EN 1729 standart.

Article No	Seat size	Size
112 710007	H 46cm, 42x40cm, Size 7	48x51/88cm
112 710006	H 46cm, 42x40cm, Size 6	47x49/83cm
112 710005	H 42cm, 36x34cm, Size 5	44x44/75cm
112 710004	H 38cm, 36x34cm, Size 4	43x43/71cm





### Chair UNIVERSAL

School chair with classic, metal frame.  
Economical option for furnishing of study halls.

Maximum weight of the seated 120kg.  
Steel frame made of 21mm tube.  
Polymer powder coating in RAL colours.  
Seat and backrest made of 7mm beech plywood.  
Durable plastic glide plugs.  
Stackable up to 6 pieces.  
Made in Bulgaria.  
The product complies with EN 1729 standart.

Article No	Seat size	Size
112 300006	H 46cm, 40x41cm, Size 6	46x54/83cm
112 300005	H 42cm, 35x36cm, Size 5	42x47/76cm
112 300004	H 38cm, 35x36cm, Size 4	42x46/69cm



### Chair UNIVERSAL upholstered

School chair with classic, metal frame.  
Economical option for furnishing of study halls.

Maximum weight of the seated 120kg.  
Steel frame made of 21mm tube.  
Polymer powder coating in RAL colours.  
Upholstered seat and backrest made of 7mm plywood.  
Durable plastic glide plugs.  
Stackable up to 6 pieces.  
Made in Bulgaria.  
The product complies with EN 1729 standart.

Article No	Seat size	Size
112 300026	H 46cm, 40x41cm, Size 6	46x54/83cm
112 300025	H 42cm, 35x36cm, Size 5	42x47/76cm
112 300024	H 38cm, 35x36cm, Size 4	42x46/69cm



### Chair ERGO active

School chair with metal legs and polyurethane monoblock in several colors. Allows sitting in both directions. Resistant to cleaning with water.

Maximum weight of the seated 120kg.  
Steel frame made of 25mm tube.  
Polymer powder coating in RAL colours.  
Polyurethane seatshell.  
Durable plastic glide plugs.  
Stackable up to 4 pieces.  
Made in Bulgaria.  
The product complies with EN 1729 standart.

Article No	Seat size	Size
112 740006	H 46cm, 42x40cm, Size 6	47x49/83cm
112 740005	H 42cm, 36x34cm, Size 5	44x44/75cm
112 740004	H 38cm, 36x34cm, Size 4	43x43/71cm

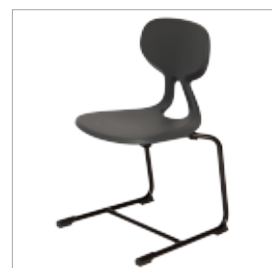



Size **6** **5** **4**

### Adjustable chair ATLAS

School chair with three fixed positions.  
Seat height 46cm, 42cm, 38cm.  
Easy to place on the table top for easy daily cleaning of the halls.

Maximum weight of the seated 150kg.  
Steel frame made of 28mm and 32mm tube.  
Polymer powder coating in RAL colours.  
Seat and backrest made of 7mm beech plywood.  
Durable plastic glide plugs.  
Made in Bulgaria.  
The product complies with EN 1729 standart.

<b>Article No</b>	<b>Seat size</b>	<b>Size</b>
112 890006	40x41cm, H 46/42/38cm	48x54/83cm



Size **6** **5** **4**

### Adjustable chair ATLAS upholstered

School chair with three fixed positions.  
Seat height 46cm, 42cm, 38cm.  
Easy to place on the table top for easy daily cleaning of the halls.

Maximum weight of the seated 150kg.  
Steel frame made of 28mm and 32mm tube.  
Polymer powder coating in RAL colours.  
Upholstered seat and backrest made of 7mm plywood.  
Durable plastic glide plugs.  
Made in Bulgaria.  
The product complies with EN 1729 standart.

<b>Article No</b>	<b>Seat size</b>	<b>Size</b>
112 890026	40x41cm, H 46/42/38cm	48x54/83cm



Size **6** **5** **4**

### Chair TINA

School chair with console, metal frame.  
Easy to place on the table top for easy daily cleaning of the halls.

Maximum weight of the seated 120kg.  
Steel frame made of 30x15mm oval tube.  
Polymer powder coating in RAL colours.  
Seat and backrest made of 7mm beech plywood.  
Durable plastic glide plugs.  
Stackable up to 5 pieces.  
Made in Bulgaria.  
The product complies with EN 1729 standart.

<b>Article No</b>	<b>Seat size</b>	<b>Size</b>
112 100006	H 46cm, 40x41cm, Size 6	46x54/83cm
112 100005	H 42cm, 35x36cm, Size 5	42x47/76cm
112 100004	H 38cm, 35x36cm, Size 4	42x46/69cm





Size **6** **5** **4**

### Chair PICO active

Console chair with a light, springy effect when sitting. Easy to place on the table top for easy daily cleaning of the halls.

Maximum weight of the seated 120kg.  
Steel frame made of 25mm tube.  
Polymer powder coating in RAL colours.  
Seat and backrest made of 7mm beech plywood.  
Durable plastic glide plugs.  
Stackable up to 5 pieces.  
Made in Bulgaria.  
The product complies with EN 1729 standart.

Article No	Seat size	Size
112 840006	H 46cm, 40x41cm, Size 6	47x53/83cm
112 840005	H 42cm, 35x36cm, Size 5	44x46/76cm
112 840004	H 38cm, 35x36cm, Size 4	44x45/70cm



Size **6** **5** **4**

### Chair PICO active upholstered

Console chair with a light, springy effect when sitting. Easy to place on the table top for easy daily cleaning of the halls.

Maximum weight of the seated 120kg.  
Steel frame made of 25mm tube.  
Polymer powder coating in RAL colours.  
Upholstered seat and backrest made of 7mm plywood.  
Durable plastic glide plugs.  
Stackable up to 5 pieces.  
Made in Bulgaria.  
The product complies with EN 1729 standart.

Article No	Seat size	Size
112 840006	H 46cm, 40x41cm, Size 6	47x53/83cm
112 840005	H 42cm, 35x36cm, Size 5	44x46/76cm
112 840004	H 38cm, 35x36cm, Size 4	44x45/70cm



Size **6** **5** **4**

### Chair TINA upholstered

School chair with console, metal frame. Easy to place on the table top for easy daily cleaning of the halls.

Maximum weight of the seated 120kg.  
Steel frame made of 30x15mm oval tube.  
Polymer powder coating in RAL colours.  
Upholstered seat and backrest made of 7mm plywood.  
Durable plastic glide plugs.  
Stackable up to 5 pieces.  
Made in Bulgaria.  
The product complies with EN 1729 standart.

Article No	Seat size	Size
112 100026	H 46cm, 40x41cm, Size 6	46x54/83cm
112 100025	H 42cm, 35x36cm, Size 5	42x47/76cm
112 100024	H 38cm, 35x36cm, Size 4	42x46/69cm







### Screw chair ERGO

Laboratory chair with screw adjustment.  
 Seat height from 40 to 53 cm.  
 Polyurethane seatshell in several colors.  
 Allows comfortable seating in two directions.  
 Maximum weight of the seated 120 kg.  
 Base made of steel tube Ø40 and Ø21mm.  
 Powder coating in RAL colors.  
 Made in Bulgaria.

<b>Article No</b>	<b>Seat size</b>	<b>Size</b>
111 070060	42x40/H 40~53cm	58x58cm



### Screw chair ERGO high

Laboratory chair with screw adjustment.  
 Seat height from 50 to 63 cm.  
 Polyurethane seatshell in several colors.  
 Allows comfortable seating in two directions.  
 Water resistant.  
 Steel ring for the legs.  
 Maximum weight of the seated 120 kg.  
 Base made of steel tube Ø40 and Ø21mm.  
 Powder coating in RAL colors.  
 Made in Bulgaria.

<b>Article No</b>	<b>Seat size</b>	<b>Size</b>
111 070070	42x40/H 50~63cm	58x58cm



### Screw chair ERGO mobile

Laboratory chair with screw adjustment.  
 Seat height from 40 to 53 cm.  
 Polyurethane seatshell in several colors.  
 Allows comfortable seating in two directions.  
 Maximum weight of the seated 120 kg.  
 Base made of steel tube Ø40 and Ø21mm.  
 Powder coating in RAL colors.  
 Sturdy plastic wheels.  
 Made in Bulgaria.

<b>Article No</b>	<b>Seatsize</b>	<b>Size</b>
111 070065	42x40/H 40~53cm	61x61cm



### Mobile chair ERGO

Mobile school chair.  
 Polyurethane seatshell in several colors.  
 Allows comfortable seating in two directions.  
 Maximum weight of the sitting 120 kg.  
 Base made of steel tube with a diameter of 25 mm.  
 Sturdy, plastic wheels.  
 Made in Bulgaria.  
 The product complies with EN 1729 standart.

<b>Article No</b>	<b>Seat size</b>	<b>Size</b>
112 710065	42x40/H 46cm	50x57/H82cm





### Screw chair 40 ~ 53cm

Laboratory chair with screw adjustment.  
 Seat height from 40 to 53 cm.  
 Seat and back varnished or upholstered.  
 Maximum weight of the seated 120 kg.  
 Base made of steel tube Ø40 and Ø21mm.  
 Powder coating in RAL colors.  
 Wear-resistant, plastic steps.  
 Made in Bulgaria.  
 The product complies with EN 1729 standart.

Article No	Seat size	Size
111 050060	40x41/H 40~53cm	58x58cm
111 050062	40x41/H 40~53cm	58x58cm



### Screw chair 50 ~ 63cm

Laboratory chair with screw adjustment.  
 Seat height from 50 to 63 cm.  
 Seat and back varnished or upholstered.  
 Steel ring for the legs.  
 Maximum weight of the sitting 120 kg.  
 Base made of steel tube Ø40 and Ø21mm.  
 Powder coating in RAL colors.  
 Wear-resistant, plastic steps.  
 Made in Bulgaria.  
 The product complies with EN 1729 standard.

Article No	Seat size	Size
111 050070	40x41/H 50~63cm	58x58cm
111 050072	40x41/H 50~63cm	58x58cm



### Screw stool 40 ~ 53cm

Laboratory chair with screw adjustment.  
 Seat height from 40 to 53 cm.  
 Varnished or upholstered seat.  
 Base made of steel tube Ø40 and Ø21mm.

Article No	Seat size	Size
114 040009	Ø35/H 40~53cm	42x42cm
114 040019	Ø35/H 40~53cm	42x42cm



### Screw stool 50 ~ 63cm

Laboratory stool with screw adjustment.  
 Seat height from 50 to 63 cm.  
 Varnished or upholstered seat.  
 Steel ring for the legs.  
 Maximum weight of the seated 120 kg.  
 Base made of steel tube Ø40 and Ø21mm.  
 Powder coating in RAL colors.  
 Wear-resistant, plastic steps.  
 Made in Bulgaria.

Article No	Seatshell	Size
113 040009	Ø35/H 50~63cm	42x42cm
113 040019	Ø35/H 50~63cm	42x42cm



## Single table RONDO

Single school table with reinforced metal construction. Suitable for high-intensity study halls. Options with rectangular tabletop or rounded corners. An additional option for leveling steps.

Tabletop 70x50cm of 18mm laminated chipboard with 2mm edge. Front and shelf of 18mm laminated chipboard with 0,5mm edge. Option for mounting a steel wire shelf /p.17/. Metal frame with 40mm steel tube legs. Crossbars under the tabletop made of profile 40x20mm. Metal hanger for school bag is included. Polymer powder coating in the RAL colors. Durable plastic glide plugs. Made in Bulgaria. The product complies with EN 1729 standart.



Size 7 6 5 4

## Single table RONDO with rectangular tabletop



### Single table RONDO

Article No	EN 1729 Size	Tabletop
122 210007	H 82cm, Size 7	70x50cm
122 210006	H 76cm, Size 6	70x50cm
122 210005	H 71cm, Size 5	70x50cm
122 210004	H 65cm, Size 4	70x50cm

### Single table RONDO with front

Article No	EN 1729 Size	Tabletop
122 210107	H 82cm, Size 7	70x50cm
122 210106	H 76cm, Size 6	70x50cm
122 210105	H 71cm, Size 5	70x50cm
122 210104	H 65cm, Size 4	70x50cm

### Single table RONDO with front and shelf

Article No	EN 1729 Size	Tabletop
122 210207	H 82cm, Size 7	70x50cm
122 210206	H 76cm, Size 6	70x50cm
122 210205	H 71cm, Size 5	70x50cm
122 210204	H 65cm, Size 4	70x50cm

## Single table RONDO with rounded corners of the tabletop



### Single table RONDO

Article No	EN 1729 Size	Tabletop
122 211007	H 82cm, Size 7	70x50cm
122 211006	H 76cm, Size 6	70x50cm
122 211005	H 71cm, Size 5	70x50cm
122 211004	H 65cm, Size 4	70x50cm

### Single table RONDO with shelf

Article No	EN 1729 Size	Tabletop
122 211107	H 82cm, Size 7	70x50cm
122 211106	H 76cm, Size 6	70x50cm
122 211105	H 71cm, Size 5	70x50cm
122 211104	H 65cm, Size 4	70x50cm

### Single table RONDO with front and shelf

Article No	EN 1729 Size	Tabletop
122 211207	H 82cm, Size 7	70x50cm
122 211206	H 76cm, Size 6	70x50cm
122 211205	H 71cm, Size 5	70x50cm
122 211204	H 65cm, Size 4	70x50cm

## Single table TINA

Single school table with cantilever structure.  
A modern look with clean lines.  
Options with rectangular top or rounded corners.

Tabletop 70x50cm of 18mm laminated chipboard with 2mm edge.  
Front and shelf of 18mm laminated chipboard with 0,5mm edge.  
Option for mounting a steel wire shelf /p.17/.  
Metal frame with 40x20mm steel profile legs.  
Crossbars under the tabletop made of square profile 20x20mm.  
Metal hanger for school bag is included.  
Polymer powder coating in the RAL colors.  
Durable plastic glide plugs with hard fixture.  
Made in Bulgaria.  
The product complies with EN 1729 standart.



## Single table TINA with rectangular tabletop



### Single table TINA

Article No	EN 1729 Size	Tabletop
122 110006	H 76cm, Size 6	70x50cm
122 110005	H 71cm, Size 5	70x50cm
122 110004	H 65cm, Size 4	70x50cm

### Single table TINA with front

Article No	EN 1729 Size	Tabletop
122 110106	H 76cm, Size 6	70x50cm
122 110105	H 71cm, Size 5	70x50cm
122 110104	H 65cm, Size 4	70x50cm

### Single table TINA with front and shelf

Article No	EN 1729 Size	Tabletop
122 110206	H 76cm, Size 6	70x50cm
122 110205	H 71cm, Size 5	70x50cm
122 110204	H 65cm, Size 4	70x50cm

## Single table TINA with rounded corners of the tabletop



### Single table TINA

Article No	EN 1729 Size	Tabletop
122 111006	H 76cm, Size 6	70x50cm
122 111005	H 71cm, Size 5	70x50cm
122 111004	H 65cm, Size 4	70x50cm

### Single table TINA with front

Article No	EN 1729 Size	Tabletop
122 111106	H 76cm, Size 6	70x50cm
122 111105	H 71cm, Size 5	70x50cm
122 111104	H 65cm, Size 4	70x50cm

### Single table TINA with front and shelf

Article No	EN 1729 Size	Tabletop
122 111206	H 76cm, Size 6	70x50cm
122 111205	H 71cm, Size 5	70x50cm
122 111204	H 65cm, Size 4	70x50cm



## Single table UNIVERSAL

Single school table with metal frame.  
Options with rectangular top or rounded corners.

Tabletop 70x50cm made of 18mm chipboard with 2mm edge.  
Front and shelf made of 18mm chipboard with 0,5mm edge.  
Option for mounting a steel wire shelf /p.17/.  
Metal frame made of rectangular profile 20x20mm.  
Reinforcing crossbars under the tabletop.  
Metal hanger for school bag is included.  
Polymer powder coating in the RAL colors.  
Durable plastic glide plugs with hard fixture.  
Made in Bulgaria.

The product complies with EN 1729 standart.

### Single table UNIVERSAL with front and shelf

Article No	EN 1729 Size	Tabletop
122 310206	H 76cm, Size 6	70x50cm
122 310205	H 71cm, Size 5	70x50cm
122 310204	H 65cm, Size 4	70x50cm

## Single table UNIVERSAL with rounded corners of the tabletop



### Single table UNIVERSAL with front

Article No	EN 1729 Size	Tabletop
122 310106	H 76cm, Size 6	70x50cm
122 310105	H 71cm, Size 5	70x50cm
122 310104	H 65cm, Size 4	70x50cm

### Single table UNIVERSAL with front

Article No	EN 1729 Size	Tabletop
122 311106	H 76cm, Size 6	70x50cm
122 311105	H 71cm, Size 5	70x50cm
122 311104	H 65cm, Size 4	70x50cm

### Table UNIVERSAL with front and shelf

Article No	EN 1729 Size	Tabletop
122 311206	H 76cm, Size 6	70x50cm
122 311205	H 71cm, Size 5	70x50cm
122 311204	H 65cm, Size 4	70x50cm





Size **6** **5** **4**

### Single, adjustable table ATLAS

Single school table adjustable in height.  
 Reliable fixing in three standart sizes.  
 Size 4: hight 65cm (1÷4 grade)  
 Size 5: hight 71cm (5÷7 grade)  
 Size 6: hight 76cm (over 8 grade)  
 Options with rectangular top or rounded corners.

Tabletop 70x50cm made of 18mm chipboard with 2mm edge.  
 Option for mounting a steel wire shelf /p.17/.  
 Metal frame with legs made of 28mm and 32mm tube.  
 Reinforcing crossbar under the tabletop.  
 Metal hanger for school bag is included.  
 Polymer powder coating in the RAL colors.  
 Durable plastic glide plugs with hard fixture.  
 Made in Bulgaria.  
 The product complies with EN 1729 standart.

#### Adjustable table ATLAS with front

Article No	EN 1729 Size	Tabletop
122 610109	H 76; 71; 65cm	70x50cm

### Single table ATLAS with rounded corners of the tabletop



Adjustable table ATLAS  
 Article No EN 1729 Size Tabletop  
 122 610009 H 76; 71; 65cm 70x50cm



Adjustable table ATLAS  
 Article No EN 1729 Size Tabletop  
 122 611009 H 76; 71; 65cm 70x50cm



Adjustable table ATLAS with front  
 Article No EN 1729 Size Tabletop  
 122 611109 H 76; 71; 65cm 70x50cm

### Single table ATLAS with mounted steel wire shelf for study supplies /p. 17/





## Single school table SAVULEN

Single school table with metal frame.  
Options with rectangular top or rounded corners.

### Single table SAVULEN with rectangular tabletop

Single table SAVULEN with front and shelf

Article No	EN 1729 Size	Tabletop
122 410206	H 76cm, Size 6	70x50cm
122 410205	H 71cm, Size 5	70x50cm
122 410204	H 65cm, Size 4	70x50cm



### Single table SAVULEN with rounded corners

Single table SAVULEN with front and shelf

Article No	EN 1729 Size	Tabletop
122 411206	H 76cm, Size 6	70x50cm
122 411205	H 71cm, Size 5	70x50cm
122 411204	H 65cm, Size 4	70x50cm



Tabletop 70x50cm made of 18mm chipboard with 2mm edge.  
Front and shelf made of 18mm chipboard with 0,5mm edge.  
Metal frame with 25mm tube legs.

Reinforcing crossbars under the tabletop.

Metal hanger for school bag is included.

Polymer powder coating in the RAL colors.

Made in Bulgaria.

The product complies with EN 1729 standart.

## Single table HAPPY

Single school table made of laminated chipboard.  
Options with rectangular tabletop or rounded corners.



### Single table HAPPY with rectangular tabletop

Single table HAPPY with front and shelf

Article No	EN 1729 Size	Tabletop
122 510206	H 76cm, размер 6	70x50cm
122 510205	H 71cm, размер 5	70x50cm
122 510204	H 65cm, размер 4	70x50cm



### Single table HAPPY with rounded corners

Single table HAPPY with front and shelf

Article No	EN 1729 Size	Tabletop
122 511206	H 76cm, Size 6	70x50cm
122 511205	H 71cm, Size 5	70x50cm
122 511204	H 65cm, Size 4	70x50cm



Tabletop 70x50cm made of 18mm chipboard with 2mm edge.  
Legs and shelf made of 18mm chipboard with 0,5mm edge.

Decors for laminated chipboard on page 44.

Made in Bulgaria.

The product complies with EN 1729 standart.

### Single school table COMBO stackable

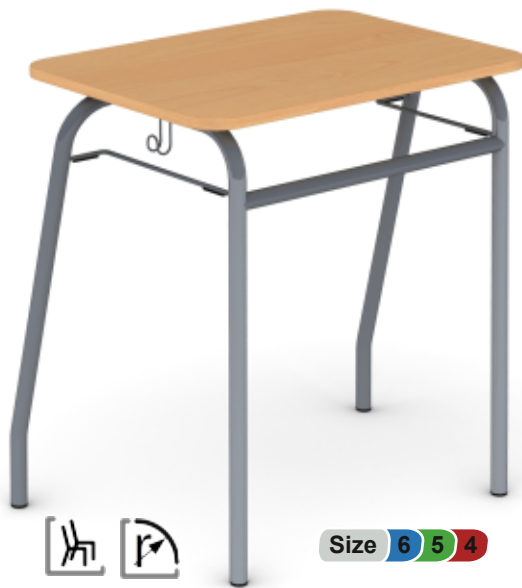

Single stackable, school table COMBO.  
Options with rectangular tabletop or rounded corners.  
The frame allows stacking and lining of the tables in variety of working configurations.

Tabletop 70x50cm made of 18mm chipboard with 2mm edge.  
Option for mounting a steel wire shelf.  
Metal frame with 28mm tube legs.  
Reinforcing crossbars under the tabletop.  
Metal hanger for school bag is included.  
Polymer powder coating in the RAL colors.  
The product complies with EN 1729 standart.

#### Single table COMBO

Article No	EN 1729 Size	Tabletop
122 810006	H 76cm, Size 6	70x50cm
122 810005	H 71cm, Size 5	70x50cm

#### Single table COMBO with rounded corners

Article No	EN 1729 Size	Tabletop
122 811006	H 76cm, Size 6	70x50cm
122 811005	H 71cm, Size 5	70x50cm

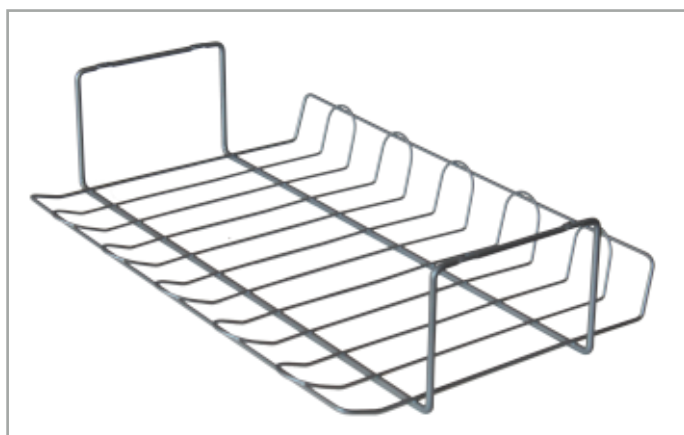

### Wire basket for school table

Easy mounting on for all tables offered.  
Dust finish in colours according to RAL.  
Made in Bulgaria

#### Wire basket for school table

Article No	Dimensions
129 951000	50x30/H12cm





## Double school table RONDO

Double school table with reinforced metal construction. Suitable for high-intensity study halls. Options with rectangular tabletop or rounded corners. An additional option for leveling steps.

Tabletop 120x50cm of 18mm laminated chipboard with 2mm edge. Front and shelf of 18mm laminated chipboard with 0,5mm edge. Option for mounting a steel wire shelves /p.17/. Metal frame with 40mm steel tube legs. Crossbars under the tabletop made of profile 40x20mm. Metal hanger for school bag is included. Polymer powder coating in the RAL colors. Durable plastic glide plugs. Made in Bulgaria. The product complies with EN 1729 standart.

## Double table RONDO with rectangular tabletop



### Double table RONDO

Article No	EN 1729 Size	Tabletop
122 220007	H 82cm, Size 7	120x50cm
122 220006	H 76cm, Size 6	120x50cm
122 220005	H 71cm, Size 5	120x50cm
122 220004	H 65cm, Size 4	120x50cm

### Double table RONDO with front

Article No	EN 1729 Size	Tabletop
122 220107	H 82cm, Size 7	120x50cm
122 220106	H 76cm, Size 6	120x50cm
122 220105	H 71cm, Size 5	120x50cm
122 220104	H 65cm, Size 4	120x50cm

### Double table RONDO with front and shelf

Article No	EN 1729 Size	Tabletop
122 220207	H 82cm, Size 7	120x50cm
122 220206	H 76cm, Size 6	120x50cm
122 220205	H 71cm, Size 5	120x50cm
122 220204	H 65cm, Size 4	120x50cm

## Double table RONDO with rounded corners of the tabletop



### Double table RONDO

Article No	EN 1729 Size	Tabletop
122 221007	H 82cm, Size 7	120x50cm
122 221006	H 76cm, Size 6	120x50cm
122 221005	H 71cm, Size 5	120x50cm
122 221004	H 65cm, Size 4	120x50cm

### Double table RONDO with front

Article No	EN 1729 Size	Tabletop
122 221107	H 82cm, Size 7	120x50cm
122 221106	H 76cm, Size 6	120x50cm
122 221105	H 71cm, Size 5	120x50cm
122 221104	H 65cm, Size 4	120x50cm

### Double table RONDO with front and shelf

Article No	EN 1729 Size	Tabletop
122 221207	H 82cm, Size 7	120x50cm
122 221206	H 76cm, Size 6	120x50cm
122 221205	H 71cm, Size 5	120x50cm
122 221204	H 65cm, Size 4	120x50cm

## Double adjustable table ATLAS

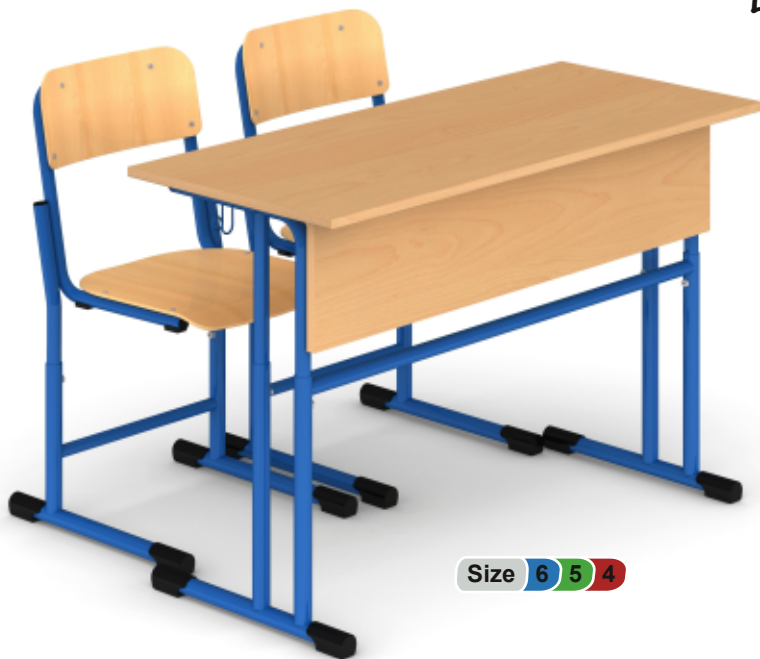

Size **6** **5** **4**

Double school table adjustable in height.  
 Reliable fixing in three standart sizes.  
 Size 4: hight 65cm (1+4 grade)  
 Size 5: hight 71cm (5+7 grade)  
 Size 6: hight 76cm (over 8 grade)  
 Options with rectangular top or rounded corners.  
 Tabletop 120x50cm made of 18mm chipboard with 2mm edge.  
 Option for mountig a steel wire shelves /p17/.  
 Metal frame with legs made of 28mm and 32mm tube.  
 Reinforcing crossbar under the tabletop.  
 Metal hanger for school bag is included.  
 Polymer powder coating in the RAL colors.  
 Durable plastic glide plugs with hard fixture.  
 Made in Bulgaria.  
 The product complies with EN 1729 standart.

**Double adjustable table ATLAS with front**  
**Article No EN 1729 Size Tabletop**  
 122 620109 H 76; 71; 65cm 120x50cm

## Adjustable table ATLAS with rounded edges of the tabletop



**Double adjustable table ATLAS**  
**Article No EN 1729 Size Tabletop**  
 122 620009 H 76; 71; 65cm 120x50cm



**Double adjustable table ATLAS**  
**Article No EN 1729 Size Tabletop**  
 122 621009 H 76; 71; 65cm 120x50cm



**Double adjustable table ATLAS with front**  
**Article No EN 1729 Size Tabletop**  
 122 621109 H 76; 71; 65cm 120x50cm



## Double school table UNIVERSAL



Double school table with metal frame.  
Options with rectangular top or rounded corners.

Tabletop 120x50cm made of 18mm chipboard with 2mm edge.  
Front and shelf made of 18mm chipboard with 0,5mm edge.  
Option for mounting a steel wire shelves /p17/.  
Metal frame made of rectangular profile 20x20mm.  
Reinforcing crossbars under the tabletop.  
Metal hanger for school bag is included.  
Polymer powder coating in the RAL colors.  
Durable plastic glide plugs with hard fixture.  
Made in Bulgaria.  
The product complies with EN 1729 standart.

### Double table UNIVERSAL with front and shelf

Article No	EN 1729 Size	Tabletop
122 320206	H 76cm, Size 6	120x50cm
122 320205	H 71cm, Size 5	120x50cm
122 320204	H 65cm, Size 4	120x50cm

## Table UNIVERSAL with rounded corners of the tabletop



### Double table UNIVERSAL with front

Article No	EN 1729 Size	Tabletop
122 320006	H 76cm, Size 6	120x50cm
122 320005	H 71cm, Size 5	120x50cm
122 320004	H 65cm, Size 4	120x50cm

### Double table UNIVERSAL with front

Article No	EN 1729 Size	Tabletop
122 321106	H 76cm, Size 6	120x50cm
122 321105	H 71cm, Size 5	120x50cm
122 321104	H 65cm, Size 4	120x50cm

### Table UNIVERSAL with front and shelf

Article No	EN 1729 Size	Tabletop
122 321206	H 76cm, Size 6	120x50cm
122 321205	H 71cm, Size 5	120x50cm
122 321204	H 65cm, Size 4	120x50cm



## Double school table TINA

Double school table with cantilever structure.  
A modern look with clean lines.  
Options with rectangular top or rounded corners.

Tabletop 120x50cm made of 18mm chipboard with 2mm edge.  
Front and shelf of 18mm laminated chipboard with 0,5mm edge.  
Option for mounting a steel wire shelves /p17/.  
Metal frame with 40x20mm steel profile legs.  
Crossbars under the tabletop made of square profile 20x20mm.  
Metal hanger for school bag is included.  
Polymer powder coating in the RAL colors.  
Durable plastic glide plugs with hard fixture.  
Made in Bulgaria.  
The product complies with EN 1729 standart.



## Double school table TINA with rectangular tabletop



**Double table TINA**

Article No	EN 1729 Size	Tabletop
122 120006	H 76cm, Size 6	120x50cm
122 120005	H 71cm, Size 5	120x50cm
122 120004	H 65cm, Size 4	120x50cm

**Double table TINA with front**

Article No	EN 1729 Size	Tabletop
122 120106	H 76cm, Size 6	120x50cm
122 120105	H 71cm, Size 5	120x50cm
122 120104	H 65cm, Size 4	120x50cm

**Double table TINA with front and shelf**

Article No	EN 1729 Size	Tabletop
122 120206	H 76cm, Size 6	120x50cm
122 120205	H 71cm, Size 5	120x50cm
122 120204	H 65cm, Size 4	120x50cm

## Double school table TINA with rounded corners of the tabletop

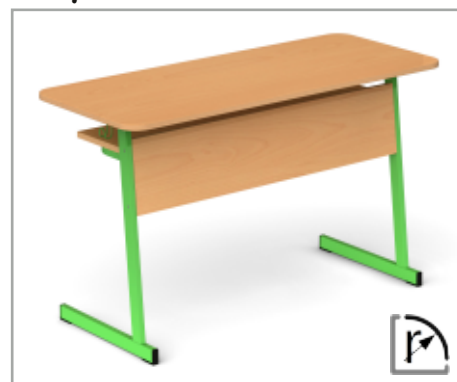

**Double table TINA**

Article No	EN 1729 Size	Tabletop
122 121006	H 76cm, Size 6	120x50cm
122 121005	H 71cm, Size 5	120x50cm
122 121004	H 65cm, Size 4	120x50cm

**Double table Tina with front**

Article No	EN 1729 Size	Tabletop
122 121106	H 76cm, Size 6	120x50cm
122 121105	H 71cm, Size 5	120x50cm
122 121104	H 65cm, Size 4	120x50cm

**Double table TINA with front and shelf**

Article No	EN 1729 Size	Tabletop
122 121206	H 76cm, Size 6	120x50cm
122 121205	H 71cm, Size 5	120x50cm
122 121204	H 65cm, Size 4	120x50cm



## Double school table SAVULEN

Double school table with metal frame.  
Options with rectangular top or rounded corners.

### Table SAVULEN with rectangular tabletop

Double table SAVULEN with front and shelf

Article No	EN 1729 Size	Tabletop
122 420206	H 76cm, Size 6	120x50cm
122 420205	H 71cm, Size 5	120x50cm
122 420204	H 65cm, Size 4	120x50cm



Tabletop 120x50cm made of 18mm chipboard with 2mm edge.  
Front and shelf made of 18mm chipboard with 0,5mm edge.  
Metal frame with 25mm tube legs.  
Reinforcing crossbars under the tabletop.  
Metal hanger for school bag is included.  
Polymer powder coating in the RAL colors.  
Made in Bulgaria.  
The product complies with EN 1729 standart.

### Table SAVULEN with rounded corners

Double table SAVULEN with front and shelf

Article No	EN 1729 Size	Tabletop
122 421206	H 76cm, Size 6	120x50cm
122 421205	H 71cm, Size 5	120x50cm
122 421204	H 65cm, Size 4	120x50cm



Double table HAPPY with rectangular tabletop

Articel No	EN 1729 Size	Tabletop
122 520206	H 76cm, Size 6	120x50cm
122 520205	H 71cm, Size 5	120x50cm
122 520204	H 65cm, Size 4	120x50cm



Double table HAPPY with rounded edges

Article No	EN 1729 Size	Tabletop
122 521206	H 76cm, Size 6	120x50cm
122 521205	H 71cm, Size 5	120x50cm
122 521204	H 65cm, Size 4	120x50cm

## Double school table HAPPY

Double school table made of laminated chipboard.  
Options with rectangular tabletop or rounded corners.



Tabletop 120x50cm of 18mm chipboard with 2mm edge.  
Legs and front made of 18mm chipboard with 0,5mm edge.  
Decors for laminated chipboard on page 44.  
Made in Bulgaria.  
The product complies with EN 1729 standart.

## Triple table RONDO

Three-seater student table with reinforced frame. Suitable for smaller classrooms. Variants with rectangular top or rounded corners. Additional option for leveling steps.

Tabletop 180x50 cm. made of 18mm chipboard with 2mm edge. Front and shelf made of 18mm chipboard with edging 0.5 mm. Possibility to install wire shelves /p.17/. Metal frame with tube legs Ø40mm. Crossbars made of 40x20mm steel profile. Metal hangers for school bags included. Polymeric powder coating in RAL system colors. Wear-resistant, plastic steps. Made in Bulgaria. The product complies with the standard BDS EN 1729.



Size **7** **6** **5** **4**

### RONDO with front and shelf

Article No	EN 1729 Size
122 230207	H 82cm, Size 7
122 230206	H 76cm, Size 6
122 230205	H 71cm, Size 5

### RONDO with rounded corners

Article No	EN 1729 Size
122 231207	H 82cm, Size 7
122 231206	H 76cm, Size 6
122 231205	H 71cm, Size 5



### Triple table RONDO with front

Article No	EN 1729 Size
122 230107	H 82cm, Size 7
122 230106	H 76cm, Size 6
122 230105	H 71cm, Size 5

### RONDO with rounded corners

Article No	EN 1729 Size
122 231107	H 82cm, Size 7
122 231106	H 76cm, Size 6
122 231105	H 71cm, Size 5



### Triple table RONDO

Article No	EN 1729 Size
122 230007	H 82cm, Size 7
122 230006	H 76cm, Size 6
122 230005	H 71cm, Size 5

### RONDO with rounded corners

Article No	EN 1729 Size
122 231007	H 82cm, Size 7
122 231006	H 76cm, Size 6
122 231005	H 71cm, Size 5



Size **6** **5** **4**

### UNIVERSAL with rectangular tabletop

Article No	EN 1729 Size
122 330206	H 76cm, Size 6
122 330205	H 71cm, Size 5
122 330204	H 65cm, Size 4

### UNIVERSAL with rounded corners

Article No	EN 1729 Size
122 331206	H 76cm, Size 6
122 331205	H 71cm, Size 5
122 331204	H 65cm, Size 4

## Triple table UNIVERSAL with front and shelf

Three-seater student table with reinforced frame. Suitable for smaller classrooms. Variants with rectangular top or rounded corners.

Tabletop 180x50cm made of 18mm with 2mm edge. Front and shelf made of 18mm chipboard with edging 0.5 mm. Metal frame made of steel profile 20x20mm. Steel crossbars under the table top. Metal hangers for school bags included. Polymeric powder coating in RAL system colors. Wear-resistant, plastic steps. Made in Bulgaria. The product complies with the standard BDS EN 1729.

## School modular tables RONDO



Modular school table with reinforced metal construction. Suitable for high-intensity study halls. Options with rectangular tabletop or rounded corners. An additional option for leveling steps.

Countertops size multiples of 60 cm of 18mm laminated chipboard. Option for mounting a steel wire shelf /p.21/. Metal frame with 40mm steel tube legs. Crossbars under the tabletop made of profile 40x20mm. Polymer powder coating in the RAL colors. Durable plastic glide plugs. Made in Bulgaria. The product complies with EN 1729 standart.

### Modular table RONDO with classic tabletop



**Modular table RONDO rectangular**

Article No	EN 1729 Size	Tabletop
121 250636	H 76cm, Size 6	120x60cm
121 250635	H 71cm, Size 5	120x60cm
121 250634	H 65cm, Size 4	120x60cm



**Modular table RONDO trapezoid**

Article No	EN 1729 Size	Tabletop
121 260606	H 76cm, Size 6	120x52cm
121 260605	H 71cm, Size 5	120x52cm
121 260604	H 65cm, Size 4	120x52cm



**Modular table RONDO semicircle**

Article No	EN 1729 Size	Tabletop
121 280606	H 76cm, Size 6	120x60cm
121 280605	H 71cm, Size 5	120x60cm
121 280604	H 65cm, Size 4	120x60cm

### Modular table RONDO with rounded corners of the tabletop



**Modular table RONDO rectangular**

Article No	EN 1729 Size	Tabletop
121 251636	H 76cm, Size 6	120x60cm
121 251635	H 71cm, Size 5	120x60cm
121 251634	H 65cm, Size 4	120x60cm



**Modular table RONDO trapezoid**

Article No	EN 1729 Size	Tabletop
121 261606	H 76cm, Size 6	120x58cm
121 261605	H 71cm, Size 5	120x58cm
121 261604	H 65cm, Size 4	120x58cm



**Modular table RONDO semicircle**

Article No	EN 1729 Size	Tabletop
121 281606	H 76cm, Size 6	120x60cm
121 281605	H 71cm, Size 5	120x60cm
121 281604	H 65cm, Size 4	120x60cm

### Modular table RONDO 60x60cm.



**Modular table RONDO square**

Article No	EN 1729 Size	Tabletop
121 240606	H 76cm, Size 6	60x60cm
121 240605	H 71cm, Size 5	60x60cm
121 240604	H 65cm, Size 4	60x60cm



**Modular table RONDO square**

Article No	EN 1729 Size	Tabletop
121 240606	H 76cm, Size 6	60x60cm
121 240605	H 71cm, Size 5	60x60cm
121 240604	H 65cm, Size 4	60x60cm

Size **6** **5** **4**

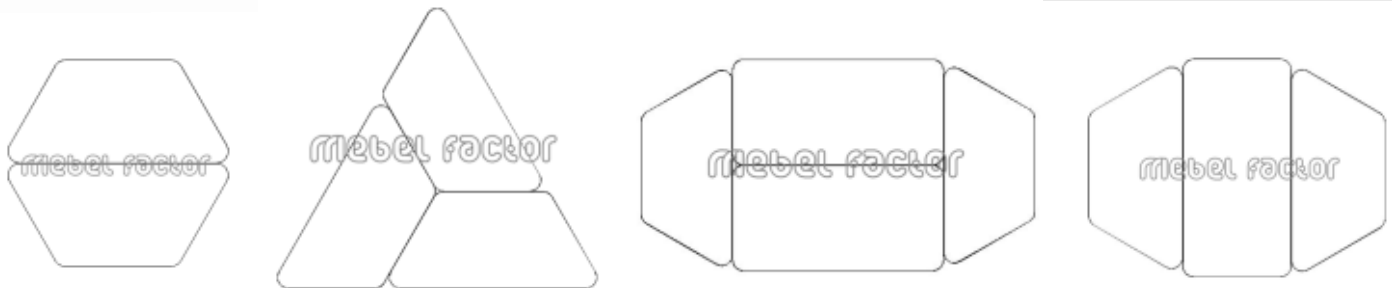

### Modular table SAVULEN hexagonal



Hexagonal modular table SAVULEN.  
 Suitable for independent and teamwork.  
 Tabletop dimensions 93x83cm. with edging 2,0mm.  
 Chipboard decors from the company cartel.  
 Welded metal frame with 25mm steel tube legs.  
 Polymer powder coating in the RAL colors.  
 Made in Bulgaria.

**Modular table SAVULEN hexagonal**

Article No	EN 1729 Size	Tabletop
121 495006	H 76cm, Size 6	93x83cm
121 495005	H 71cm, Size 5	93x83cm
121 495004	H 65cm, Size 4	93x83cm

Size **6** **5** **4**





## School modular table POLLY



Convenient for individual and collaborative work.  
Creative solution for a dynamic learning environment.

The original shape of the countertop allows diverse grouping from 3 to 10 tables.

Option with two wheels making it easy to move.

Tabletop size 76x69cm made of 18mm chipboard.

Decors of laminated chipboard from the company cartel.

Welded frame with legs made of Ø40mm steel tube.

Crossbars made of rectangular profile 40x20mm.

Polymer, powder coating in RAL colors.

Made in Bulgaria.

The product complies with the standar EN 1729.



### Mobile modular table POLLY

Article No EN 1729 Size

121 295206 H 76cm, size 6

121 295205 H 71cm, size 5

Tabletop

76x69cm

76x69cm

### Modular table POLLY

Article No EN 1729 Size

121 295006 H 76cm, size 6

121 295005 H 71cm, size 5

Tabletop

76x69cm

76x69cm



Size 6 5



## School modular tables RONDO STIFF



Stacking mobile table.  
Stacking up to 4 pieces  
Wheels with locking mechanism.  
Option without wheels on page 69.  
Convenient for quick rearrangement.  
18mm chipboard tabletop  
with 2mm edging.  
Welded frame made of Ø40mm  
steel tube and 40x20mm crossbars.  
RAL powder coating.  
Made in Bulgaria.  
Complies with the standar EN 1729.



Size 6 5

### Mobile table RONDO STIFF

Article No EN 1729 Size

127 210756 H 76cm, size 6

127 210755 H 71cm, size 5

Tabletop

70x50cm

70x50cm



## School modular table TRAPEZE M



Single modular table with trapezoidal tabletop.  
 Convenient for independent work and quick combination in groups of 3, 4 and 6 tables.  
 Two-wheel version for easy moving.  
 Wheels with foot-operated locking mechanism.  
 Possibility to install a wire shelf /p.17/  
 Laminated chipboard top 18mm with 2mm edging.  
 Welded frame with legs made of Ø40mm steel tube.  
 Crossbars made of rectangular profile 40x20mm.  
 Powder coating in RAL colors. Made in Bulgaria.  
 The product complies with the standar EN 1729.



Size **6** **5**

### Mobile modular table TRAPEZE M

Article No	EN 1729 Size	Tabletop
121 299206	H 76cm, size 6	79x50cm
121 299205	H 71cm, size 5	79x50cm

### Modular table TRAPEZE M

Article No	EN 1729 Size	Tabletop
121 299006	H 76cm, size 6	79x50cm
121 299005	H 71cm, size 5	79x50cm



## School modular table TRIA



Modular table for small classrooms with a tabletop providing enough work space.  
 Stacking up to 3 pieces.  
 Convenient for independent work and quick combination in groups of 2 or 4 tables.  
 Option with a wheel for easy movement.  
 Wheel with foot-operated locking mechanism.  
 Laminated chipboard top 18mm with edging 2mm.  
 Welded frame with legs made of Ø40mm steel tube.  
 Crossbars made of rectangular profile 40x20mm.  
 Powder coating in RAL colors.  
 Made in Bulgaria.



Size **6** **5**

### Mobile modular table TRIA

Article No	EN 1729 Size	Size
121 298206	H 76cm, size 6	82x47cm
121 298205	H 71cm, size 5	82x47cm

### Modular table TRIA

Article No	EN 1729 Size	Tabletop
121 298006	H 76cm, size 6	82x47cm
121 298005	H 71cm, size 5	82x47cm





School modular table DETELINA.  
 Suitable for independent and teamwork.  
 Combining a square of 4 pieces with size 98 cm.  
 Tabletop size 70x47cm with 2,0mm edge.  
 Chipboard decors from the company cartel.  
 Welded metal frame with 40mm steel tube legs.  
 Crossbars under the tabletop made of profile 40x20mm.  
 Polymer powder coating in the RAL colors.  
 Made in Bulgaria.  
 The product complies with EN 1729 standart.

## School modular table DETELINA

### School modular table DETELINA

Article No	EN 1729 Size	Tabletop
121 291006	H 76cm, Size 6	70x47cm
121 291005	H 71cm, Size 5	70x47cm
121 291004	H 65cm, Size 4	70x47cm

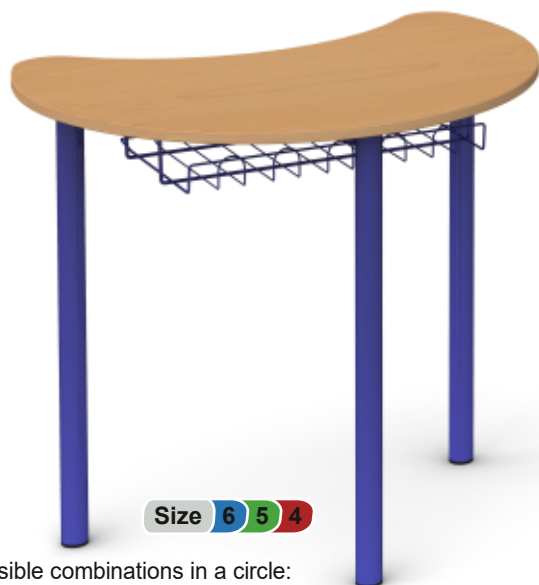

Possible combinations in a circle:  
 - 3 pcs. with diameter 135cm.  
 - 4 pcs. with diameter 145cm.  
 - 5 pcs. with diameter 160cm.  
 - 6 pcs. with diameter 175cm.  
 Tabletop size 80x60cm with 2,0mm edge.  
 Option for mounting a steel wire shelf /p17/.  
 Chipboard decors from the company cartel.  
 Welded metal frame with legs 40mm in diameter.  
 Polymer powder coating in RAL colours.  
 Made in Bulgaria.  
 This product meets the standard EN 1729.

## School modular table MARGARITA

### School modular table MARGARITA

Article No	EN 1729 Size	Tabletop
121 293006	H 76cm, Size 6	80x60cm
121 293005	H 71cm, Size 5	80x60cm
121 293004	H 65cm, Size 4	80x60cm





School modular table FLOWER.  
 Suitable for independent and teamwork.  
 Combining a square of 6 pieces with size 140 cm.  
 Tabletop size 69x56cm with 2,0mm edge.  
 Chipboard decors from the company cartel.  
 Welded metal frame with 40mm steel tube legs.  
 Crossbars under the tabletop made of profile 40x20mm.  
 Polymer powder coating in the RAL colors.  
 Made in Bulgaria.  
 The product complies with EN 1729 standart.

## School modular table FLOWER

### School modular table FLOWER

Article No	EN 1729 Size	Tabletop
121 292006	H 76cm, Size 6	69x56cm
121 292005	H 71cm, Size 5	69x56cm
121 292004	H 65cm, Size 4	69x56cm



### Modular table WAVE

Article No	EN 1729 Size	Tabletop
121 494006	H 76cm, Size 6	76x62cm
121 494005	H 71cm, Size 5	76x62cm
121 494004	H 65cm, Size 4	76x62cm

## Modular school table WAVE stacakble

The design allows for stacking and arranging in a variety of work configurations.

Stackable modular table FLOWER.  
 Suitable for independent and teamwork.  
 Combining a square of 6 pieces with size 160 cm.  
 Tabletop size 76x62cm with 2,0mm edge.  
 Chipboard decors from the company cartel.  
 Welded metal frame made of 28mm tube.  
 Polymer powder coating in the RAL colors.  
 Made in Bulgaria.  
 The product complies with EN 1729 standart.



# School combo desks / Single combo desks

## Single combo desks RONDO, rightward



Size **6** **5** **4**

Designed for sitting on the right side.  
Tabletop 60x45cm made of 18mm chipboard with 2,0mm edging.  
Front made of 18mm chipboard with 0,5mm edging.  
Chipboard decors from the company cartel.  
Welded metal frame made of 25mm steel tube.  
Metal hook for school bag included.  
Reinforcing crossbars under the tabletop.  
Polymer powder coating in RAL colours.  
Made in Bulgaria.  
The product complies with EN 1729 standart.

### Single combo desks RONDO, rightward

Article No	EN 1729 Size	Tabletop
152 210186	H 76cm, Size 6	60x45cm
152 210185	H 71cm, Size 5	60x45cm
152 210184	H 65cm, Size 4	60x45cm

### Single combo desks RONDO, rightward

Article No	EN 1729 Size	Tabletop
152 211186	H 76cm, Size 6	60x45cm
152 211185	H 71cm, Size 5	60x45cm
152 211184	H 65cm, Size 4	60x45cm

## Single combo desks RONDO, leftward



Size **6** **5** **4**

### Single combo desks RONDO, leftward

Article No	EN 1729 Size	Tabletop
152 210196	H 76cm, Size 6	60x45cm
152 210195	H 71cm, Size 5	60x45cm
152 210194	H 65cm, Size 4	60x45cm

### Single combo desks RONDO, leftward

Article No	EN 1729 Size	Tabletop
152 211196	H 76cm, Size 6	60x45cm
152 211195	H 71cm, Size 5	60x45cm
152 211194	H 65cm, Size 4	60x45cm



## Single combo desk UNIVERSAL laminated chipboard seat and backrest



Size **6** **5** **4**

Tabletop 60x45cm made of 18mm chipboard with 2mm edge.  
Front and shelf made of 18mm chipboard with 0,5mm edge.  
Seat and backrest made of laminated chipboard.  
Chipboard decors from the company cartel.  
Welded metal frame made of rectangular profile 20x20mm.  
Metal hanger for school bag is included.  
Reinforcing crossbars under the tabletop.  
Polymer powder coating in the RAL colors.  
Made in Bulgaria.  
The product complies with EN 1729 standart.

### Single combo desk UNIVERSAL

Article No	EN 1729 Size	Tabletop
152 310256	H 76cm, Size 6	60x45cm
152 310255	H 71cm, Size 5	60x45cm
152 310254	H 65cm, Size 4	60x45cm

### Single combo desk UNIVERSAL

Article No	EN 1729 Size	Tabletop
152 311256	H 76cm, Size 6	60x45cm
152 311255	H 71cm, Size 5	60x45cm
152 311254	H 65cm, Size 4	60x45cm



## Single combo desk UNIVERSAL plywood seat and backrest



Size **6** **5** **4**

### Single combo desk UNIVERSAL

Article No	EN 1729 Size	Tabletop
152 310256	H 76cm, Size 6	60x45cm
152 310255	H 71cm, Size 5	60x45cm
152 310254	H 65cm, Size 4	60x45cm

### Single combo desk UNIVERSAL

Article No	EN 1729 Size	Tabletop
152 311256	H 76cm, Size 6	60x45cm
152 311255	H 71cm, Size 5	60x45cm
152 311254	H 65cm, Size 4	60x45cm



Size **6** **5** **4**

## Double combo desk SAVULEN adjustable

Double combo desk SAVULEN adjustable  
**Article No** EN 1729 **Size** **Tabletop**  
 152 320256 H 76cm, Size 6 120x45cm

## Double combo desk SAVULEN adjustable with rounded corners of the tabletop

Double combo desk SAVULEN adjustable  
**Article No** EN 1729 **Size** **Tabletop**  
 152 321256 H 76cm, Size 6 120x45cm



Size **6** **5** **4**

Double combo desk adjustable in height.  
 Reliable fixing in three standard sizes.  
 Tabletop 120x45cm made of 18mm chipboard with 2mm edge.  
 Front and shelf made of 18mm chipboard with 0,5mm edge.  
 Chipboard decors from the company cartel.  
 Seat and backrest made of beech plywood.  
 Welded metal frame made of 25mm and 28mm steel tube.  
 Metal hangers for school bags are included.  
 Reinforcing crossbars under the tabletop.  
 Polymer powder coating in the RAL colors.  
 Made in Bulgaria.  
 The product complies with EN 1729 standard.

## Double combo desk UNIVERSAL laminated chipboard seat and backrest



Size **6** **5** **4**

Tabletop 120x45cm made of 18mm chipboard with 2mm edge.  
 Front and shelf made of 18mm chipboard with 0,5mm edge.  
 Seat and backrest made of 18mm chipboard.  
 Chipboard decors from the company cartel.  
 Welded metal frame made of 20x20mm profile.  
 Metal hangers for school bags are included.  
 Reinforcing crossbars under the tabletop.  
 Polymer powder coating in the RAL colors.  
 Made in Bulgaria.

## Double combo desk UNIVERSAL plywood seat and backrest



Size **6** **5** **4**

### Double combo desk UNIVERSAL

Article No	EN 1729 Size	Tabletop
152 320256	H 76cm, Size 6	120x45cm
152 320255	H 71cm, Size 5	120x45cm
152 320254	H 65cm, Size 4	120x45cm

### Double combo desk UNIVERSAL

Article No	EN 1729 Size	Tabletop
152 321256	H 76cm, Size 6	120x45cm
152 321255	H 71cm, Size 5	120x45cm
152 321254	H 65cm, Size 4	120x45cm



### Double combo desk UNIVERSAL

Article No	EN 1729 Size	Tabletop
152 320256	H 76cm, Size 6	120x45cm
152 320255	H 71cm, Size 5	120x45cm
152 320254	H 65cm, Size 4	120x45cm

### Double combo desk UNIVERSAL

Article No	EN 1729 Size	Tabletop
152 321256	H 76cm, Size 6	120x45cm
152 321255	H 71cm, Size 5	120x45cm
152 321254	H 65cm, Size 4	120x45cm

## Double computer table UNIVERSAL



Double computer table with reinforced metal construction.  
Options with rectangular tabletop or rounded corners.

Tabletop 180x60cm or 160x60cm made of 18mm chipboard.  
Front and shelf made of 18mm chipboard with 0,5mm edge.  
Retractable keyboard shelves and built-in computer containers.  
Welded metal frame made of rectangular profile 20x20mm.  
Reinforcing crossbars under the tabletop of profile 20x20mm.  
Polymer powder coating in the RAL colors.  
Durable plastic glide plugs.  
Made in Bulgaria.  
The product complies with EN 1729 standart.



### Computer table UNIVERSAL 180x60cm

Article No	EN 1729 Size	Tabletop
125 320216	H 76cm, Size 6	180x60cm
125 320215	H 71cm, Size 5	180x60cm
Tabletop 180x60cm with rounded corners		
125 321216	H 76cm, Size 6	180x60cm
125 321215	H 71cm, Size 5	180x60cm

### Computer table UNIVERSAL 160x60cm

Article No	EN 1729 Size	Tabletop
125 320206	H 76cm, Size 6	160x60cm
125 320205	H 71cm, Size 5	160x60cm
Tabletop 160x60cm with rounded corners		
125 321206	H 76cm, Size 6	160x60cm
125 321205	H 71cm, Size 5	160x60cm

## Single computer table UNIVERSAL



Single computer table with reinforced metal construction.  
Options with rectangular tabletop or rounded corners.

Tabletop 90x60cm made of 18mm chipboard with 2,0mm edge.  
Front and shelf made of 18mm chipboard with 0,5mm edge.  
Retractable keyboard shelves and built-in computer containers.  
Welded metal frame made of rectangular profile 20x20mm.  
Reinforcing crossbars under the tabletop of profile 20x20mm.  
Polymer powder coating in the RAL colors.  
Durable plastic glide plugs.  
Made in Bulgaria.  
The product complies with EN 1729 standart.

### Computer table UNIVERSAL 90x60cm

Article No	EN 1729 Size	Tabletop
125 310206	H 76cm, Size 6	90x60cm
125 310205	H 71cm, Size 5	90x60cm
Tabletop 90x60cm with rounded corners		
125 311206	H 76cm, Size 6	90x60cm
125 311205	H 71cm, Size 5	90x60cm

### Single computer table 90x60cm



Single computer table.  
Dimensions 90x60cm, 18mm laminated chipboard.  
Integrated computer shelf and retractable keyboard shelf.  
Made in Bulgaria.

**Computer table 610256**

Article No	EN 1729 Size	Tabletop
125 610256	H 76cm, size 6	90x60cm
<b>Tabletop 90x60cm with rounded corners</b>		
125 611256	H 76cm, size 6	90x60cm

### Computer table 90x60cm. with a metal leg



Single computer table.  
Dimensions 90x60cm, 18mm laminated chipboard.  
Integrated computer shelf and retractable keyboard shelf.  
Made in Bulgaria.

**Computer table 610266**

Article No	EN 1729 Size	Tabletop
125 610266	H 76cm, size 6	90x60cm
<b>Tabletop 90x60cm with rounded corners</b>		
125 611266	H 76cm, size 6	90x60cm



### Single drawing table TINA

Single drawing table TINA.  
Mobile tabletop 50x50cm, laminated chipboard.  
Tabletop can be adjusted in 3 positions.  
Immobile tabletop 50x25cm, laminated chipboard.  
Tabletop can be adjusted in 3 positions.  
Made in Bulgaria.

**Drawing Table TINA**

Article No	EN 1729 Size	Tabletop
125 110406	H 76cm, size 6	160x60cm
125 110405	H 71cm, size 5	160x60cm



# School furniture / Student cupboards

Internal cell sizes 38x36x56cm.  
 18mm laminated chipboard hull with edge 0.5mm.  
 Option for placing locks on the doors.  
 Chipboard decors from the company cartel.

## Student shelves and cupboards for personal belongings

### Shelves for personal belongings



**Shelf with four cells**  
**Article No** 142 332200 **Size** 82x39/H125cm



**Shelf with six cells**  
**Article No** 142 333200 **Size** 122x39/H125cm



**Shell with six cells**  
**Article No** 142 332300 **Size** 82x39/H183cm



**Shelf with nine cells**  
**Article No** 142 333300 **Size** 122x39/H183cm

### Cupboards for textbooks and personal belongings. Option for door locks.



**Cupboard with four cells**  
**Article No** 142 332214 **Size** 82x39/H125cm



**Cupboard with six cells**  
**Article No** 142 333216 **Size** 122x39/H125cm

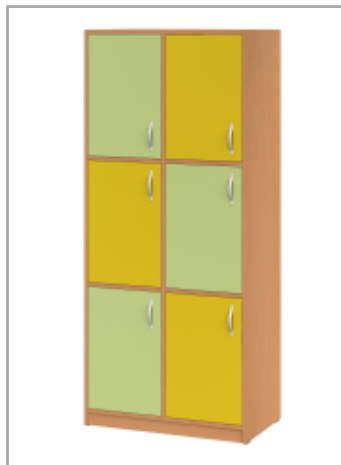

**Cupboard with six cells**  
**Article No** 142 332316 **Size** 82x39/H183cm

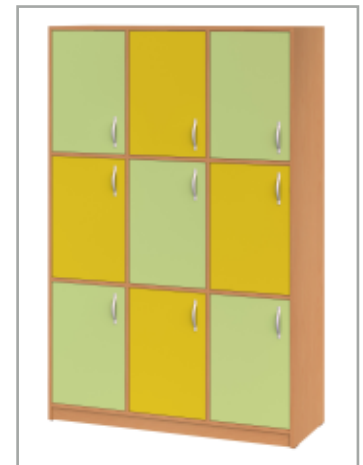

**Cupboard with nine cells**  
**Article No** 142 333319 **Size** 122x39/H183cm



Option for door locks.

*Specialized cabinets for classbooks and general ledger book*  
*Cabinet for classbooks with three doors*



**Cupboard for seven classbooks**  
**Article No** 142 153313 **Size** 130x43/H118cm



**Cupboard for fourteen classbooks**  
**Article No** 142 153314 **Size** 130x43/H118cm



**Cupboard for twentyone classbooks**  
**Article No** 142 153315 **Size** 130x43/H118cm

*Cabinet for classbooks with nine drawers*



**Cupboard for seven classbooks**  
**Article No** 142 153343 **Size** 130x43/H118cm



**Cupboard for fourteen classbooks**  
**Article No** 142 153344 **Size** 130x43/H118cm



**Cupboard for twentyone classbooks**  
**Article No** 142 153345 **Size** 130x43/H118cm

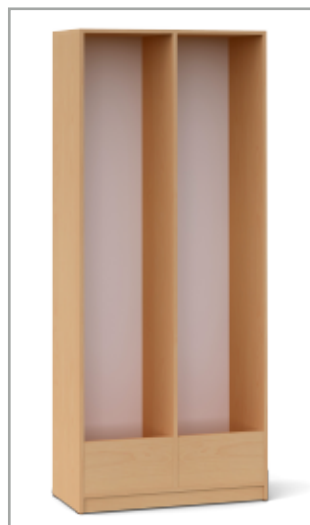

**Two-sided cabinet for maps.**  
**Article No** 142 1355K1 **Size** 80x39/H190cm

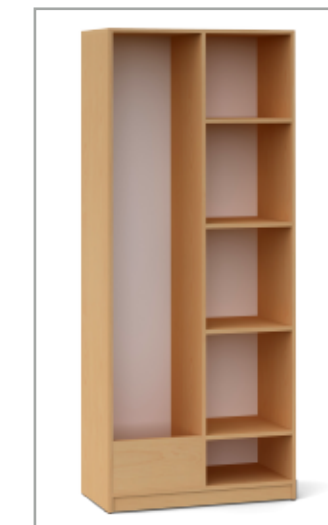

**One-sided cabinet for maps**  
**Article No** 142 1355K2 **Size** 80x39/H190cm

*Cabinets with full size doors for geographical maps*

One-sided version with shelves.  
 Two-sided option for more maps.  
 Body and doors made of 18mm chipboard.  
 Edge 2,0 mm for the doors and 0,5 mm for the body.  
 Doors with reinforced three-hinge mounting.  
 Option for placing locks.  
 Back made of 3mm laminated HDF.  
 Decors of chipboard from the company cartel.  
 Made in Bulgaria.

## Magnetic whiteboards with wings



Magnetic whiteboard for writing with markers.  
 Central panel with two side wings.  
 Five work surfaces.  
 Elegant aluminum frame.  
 A marker stand is included.  
 Designed for heavy-duty use.

### Magnetic whiteboard with wings

Article No	Size
451 053612	360x120cm/ 180x120cm
451 054812	480x120cm/ 240x120cm

## Whiteboards with aluminum frame

White boards with laminated surface for writing with markers.  
 Elegant aluminum frame with mounting holes.  
 Standard boards have two work surfaces.  
 A marker stand is included.  
 Designed for heavy-duty use.

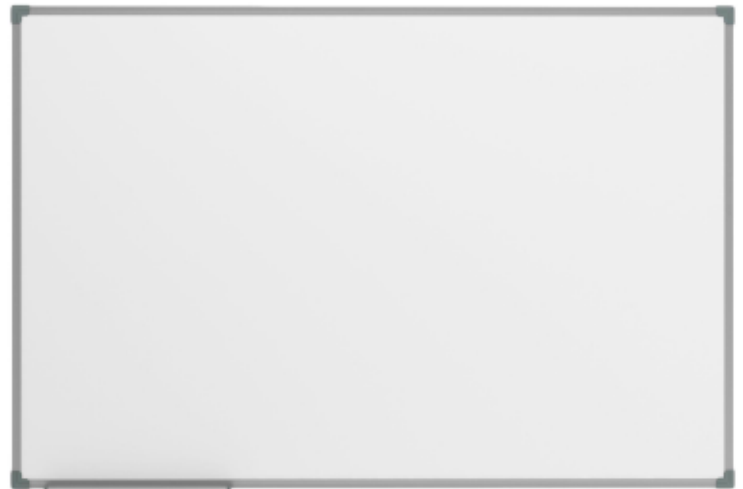

### Standard white boards

Article No	Size
451 000906	90x60cm
451 001209	120x90cm
451 001812	180x120cm
451 002412	240x120cm

### Magnetic whiteboards

Article No	Size
451 010906	90x60cm
451 011209	120x90cm
451 011812	180x120cm
451 012412	240x120cm

## Whiteboards with wooden frame



### Whiteboards with wooden frame

Article No	Size
451 060604	60x40cm
451 060906	90x60cm

### Magnetic with wooden frame

Article No	Size
451 070604	60x40cm
451 070906	90x60cm

## Cork boards with wooden frame



### Артикул

451 100403
451 100604
451 100906
451 101209

### Размери

40x30cm
60x40cm
90x60cm
120x90cm



## MakerHub Trolley with two magnetic whiteboards

MakerHub strollers are double-sided, which makes them ideal for group activities. A variety of containers can be used in MakerHubs, thanks to the flexible system of the basic storage module.

Wheels with a diameter of 75 mm for good mobility, with locking mechanism.

The standard dimensions of the whiteboard base 60x90cm allow quick replacement - just lift and pull. Switch between magnetic whiteboards, chalk boards or others to suit your activities in the classroom and age group. For added security, all standard boards are securely fastened in place between steel guides at the top of the frame and special fasteners on the shelf.



**MakerHub magnetic boards**  
**Article No**                      **Size**  
 447 MST0544    69x44/H143cm

## Mobile whiteboards

Double-sided magnetic whiteboard with horizontal rotation of the work surface.

Metal stand on wheels with the possibility of locking. Movable marker stand.



**Magnetic with wooden frame**  
**Article No**                      **Size**  
 451 031209            120x90cm  
 451 031812            180x120cm

## Stationary and mobile flipcharts

Easily portable flipchart with magnetic coating.

Options for pull-out arms. Possibility to adjust the height.

Suitable for heavy daily workloads in conference rooms, schools and universities. Model with movable base on 5 wheels and locking mechanism. Universal system for fastening flipchart blocks with different holes. Practical stand for markers.



**Mobile flipchart**  
**Article No**                      **Size**  
 451 261007            70x100cm



**Magnetic flipchart**  
**Article no**                      **Size**  
 451 211007            70x100cm  
**Flipchart with pull-out arms**  
 451 231007            70x100cm



Article No: 447 MST0144  
Size: 102,5x44/H156.5cm

## MakerSpace Trolley

Mobile workstation for STEM projects and activities.  
Encourages students to be cooperative and creative.  
Helps in organizing the learning process.  
Easy relocation of tool hangers.

The set contains:

- Sturdy steel frame and locking wheels 75mm
- Side and back panels for accessories
- Runners with protection against falling of the container.
- 3 medium F2 containers
- 12 tiles of F1 container
- 12 mini containers
- 1 roller holder
- 5 single hooks and
- 5 double hooks

Suitable for loads up to 85 kg.



## Metal storage unit Callero

CALERO is a whole set of modular elements that can be used together or separately depending on your storage requirements. You can build up or build across to make sure you get maximum storage space in the space you have.

These are some of the most popular combinations that you can order as a set for your convenience. CALERO units are designed with the possibility of stable attachment to the wall.

Metal construction with powder coating RAL9006.

Options for stationary use and mobile units with wheels 50mm or 75mm.

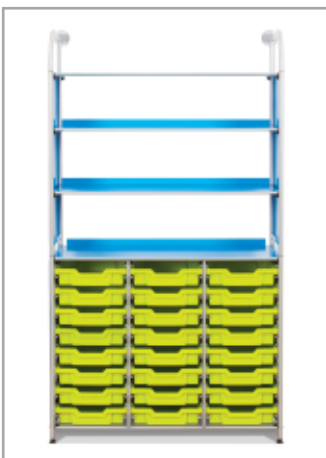

Article No: 447 CCOM11  
Size: 102x53,5/H178cm  
24 x F1 and 4 shelves



Article No: 447 CCOM12  
Size: 102x53,5/H178cm  
12 x F2 and 4 shelves



Article: 447 CCOM14  
18 x F1, 9 X F2, 3 x F3

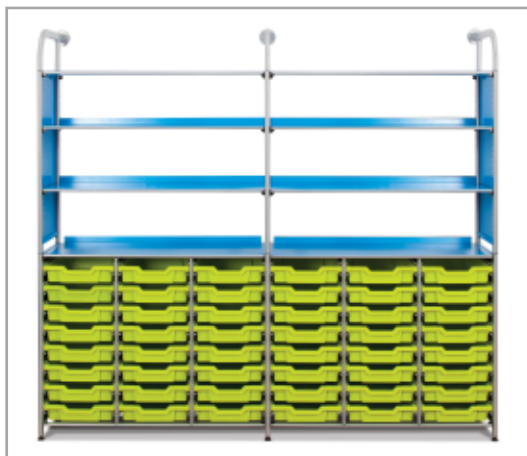

Article no: 447 CCOM01 202x43,5/H178cm.  
48 pieces trays F1 and 8 metal shelves

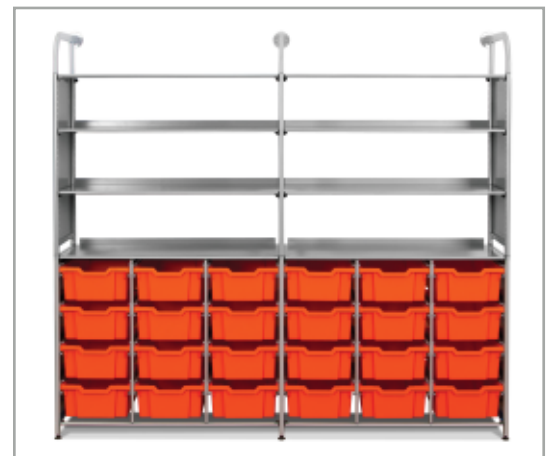

Article: 447 CCOM02 202x43,5/H178cm.  
24 pieces trays F2 and 8 metal shelves

*Mobile, triple storage units Callero with metal construction*



Article No: 447 CSET06

Size 101x43/H103cm



Article No: 447 CSET02



Article No: 447 CSET01

6 pieces trays F2



Article No: 447 CSET16

6 pieces trays F2



Article No: 447 CSET03

24 pieces trays F1



Article No: 447 CSET07

12 pieces trays F2



Article No: 447 CSET19

3 pieces F2 and 6 pieces F25



Article No: 447 CSET17

8 pieces F1 and 4 pieces F2

*Art trolleys Callero with metal construction*



Article No: 447 CSET50

Size: 50x51/H94,5cm

6 pieces trays D3



Article No: 447 CSET51

Size: 57x51/H94,5cm

8 pieces trays A1



Article No: 447 CSET52

Size: 57x51/H94,5cm

20 drying racks



Article No: 447 CSET53

Size: 57x51/H94,5cm

4 pieces A1 and 10 racks

*Double trolleys Callero with metal construction. Size 68x43/H103cm*



Article no: 447 CSET05

16 pieces trays F1



Article No: 447 CSET13

8 pieces trays F2



Article No: 447 CSET22

2 pieces F2 and 4 pieces F25



Article No: 447 CSET18

8 pieces F1 and 4 pieces F2

# Specialized furniture / Trays and inserts Gratnells



Polypropylene trays with smooth inner surface.  
 Designed for high durability with special ribbing.  
 Special runners turn each container into a drawer.  
 Designed for arranging and storing various tools.  
 Various organizers and specialized inserts.  
 Convenient for installation in specialized furniture.  
 BSI tested for severe educational use.  
 All products are completely recyclable.  
 Manufactured by Gratnells Ltd, UK.



**Shallow tray F1**  
**Article No** 441 00F100 **Size** 31,2x42,7/H7,5cm



**Deep tray F2**  
**Article No** 441 00F200 **Size** 31,2x42,7/H15cm



**Extra deep tray F25**  
**Article No** 441 00F250 **Size** 31,2x42,7/H22,5cm



**Jumbo tray F3**  
**Article No** 441 00F300 **Size** 31,2x42,7/H30cm



**Art tray A1**  
**Article No** 441 00A100 **Size** 52,5x47/H4,3cm



**Paper tray D3**  
**Article No** 441 00D300 **Size** 45,3x47,8/H8,2cm



**Quadrant tray Q2**  
**Article No** 441 00Q200 **Size** 40x40/H15cm



**Four section insert for F1**  
**Article No:** 441 01IN4



**Six section insert for F1**  
**Article No:** 441 01IN6



**Cryon insert 2 for F1**  
**Article No:** 441 01IN12C



**Thirty section insert for F1**  
**Article No:** 441 01IN30



**Office insert for F1**  
**Article No:** 441 01IN6D



## Soft inserts for trays Gratnells

## Inserts for trays Gratnells



**Transperant clip-on lid**  
**Article No:** 441 00LF10



**Insert for 30 bottles Φ45mm**  
**Article No:** 441 01F30B



**Insert for 56 bottles Φ25mm**  
**Article No:** 441 01FT56

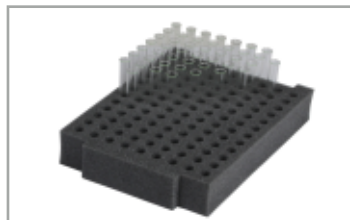

**Insert for 108 bottles Φ15mm**  
**Article No:** 441 01FT108

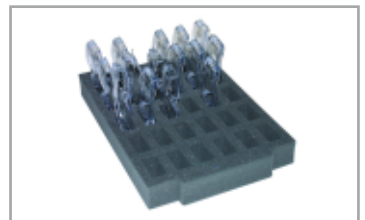

**Insert for 30 safety glasses**  
**Article No:** 441 01F30G

Mobile unit with 8 art trays A1



Article No: 147 5518A1 57,5x50/H64cm

Mobile unit for play with 12 trays F1 and F2



Article No: 147 599210 79x79/H53cm

Mobile unit with 6 paper trays D3



Article No: 147 5516D3 50,7x50/H64cm

Double mobile units with color trays Gratnells



Article No: 147 542610 70x45/H64cm  
12 trays F1



Article No: 147 542620 70x45/H64cm  
6 trays F1 and 3 trays F2



Article No: 147 542670 70x45/H64cm  
6 trays F1 and 3 shelves

Triple mobile units with color trays Gratnells



Article No: 147 543610 104x45/H64cm  
18 trays F1



Article No: 147 543612 104x45/H64cm  
6 trays F1 and 6 trays F2



Article No: 147 543640 104x45/H64cm  
8 trays F1, 2 trays F2 and 2 trays F2

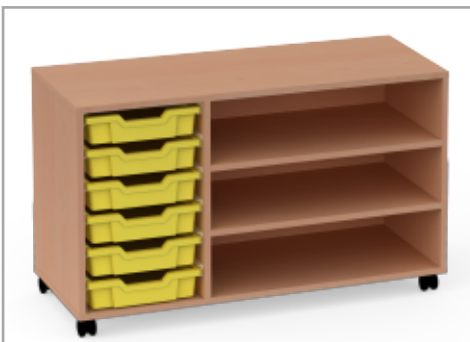

Article No: 147 543670 104x45/H64cm  
6 trays F1 and 3 shelves



Article No: 147 543680 104x45/H64cm  
12 trays F1 and 3 shelves



Article No: 147 543682 104x45/H64cm  
6 trays F1, 3 trays F2 and 3 shelves



## Specialized furniture / Shelves and cabinets

### Double units with shelf and Gratnells trays Size 70x45/H181cm



Article No: 147 142A10  
32 trays F1

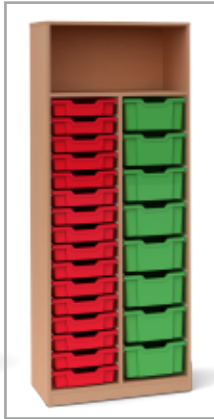

Art No: 147 142A12  
16 x F1, 8 x F2

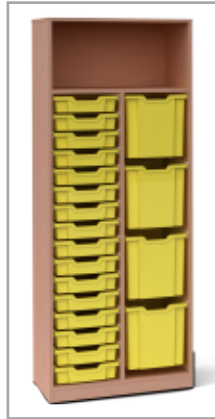

Art No: 147 142A14  
16 x F1, 4 x F3



Art No: 147 142A20  
16 броя F2

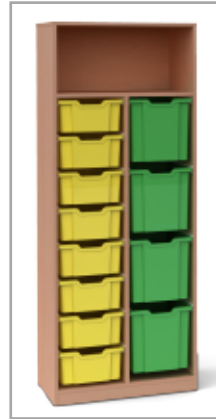

Art No: 147 142A24  
8 x F2, 4 x F3



Art No: 147 127400  
Doors for 4 levels

### Double units with two shelves and Gratnells trays Size 70x45/H181cm



Article No: 147 142B10  
24 trays F1



Art No: 147 142B12  
12 x F1, 6x F2



Art No: 147 142B14  
12 x F1, 3 x F3



Art No: 147 142B20  
12 броя F2

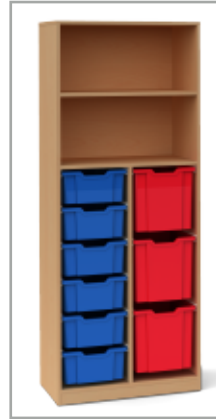

Art No: 147 142B24  
6 x F2, 3 x F3



Art No: 147 127300  
Врати 3 нива

### Double units with three shelves and Gratnells trays Size 70x45/H181cm



Article No: 147 142C10  
16 trays F1



Art No: 147 142C12  
8 x F1, 4 x F2

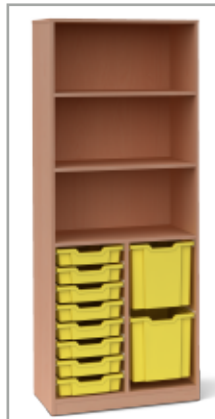

Art No: 147 142C14  
8 x F1, 2 x F3



Art No: 147 142C20  
8 броя F2



Art No: 147 142C24  
4 x F2, 2 x F3



Art No: 147 127200  
Врати 2 нива



Article No: 147 142810  
16 trays F1

## Double units with Gratnells trays Size 70x45/H79cm



Article No: 147 142812  
8 trays F1, 4 trays F2

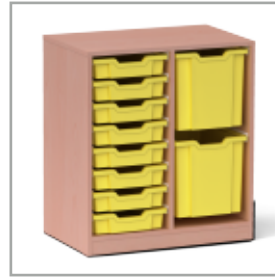

Article No: 147 142814  
8 trays F1, 2 trays F3



Article No: 147 142820  
8 trays F2

Cabinets with plastic containers Gratnells.  
18 mm laminated chipboard body with 0.5 mm edging  
Chipboard back for high durability.  
Different combinations with containers F1, F2 and F3.  
Runners turning the container into a drawer.  
Decors of laminated chipboard from the company cartel.  
Made in Bulgaria.

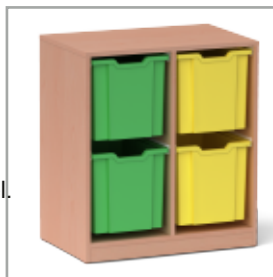

Article No: 147 142830  
4 trays F3



Article No: 147 142870  
8 trays F1



Article No: 147 142872  
4 trays F2

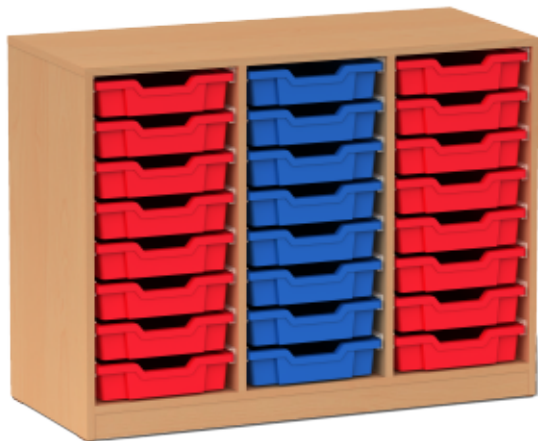

Article No: 147 143810  
24 trays F1

## Tripple units with Gratnells trays Size 104x45/H79cm

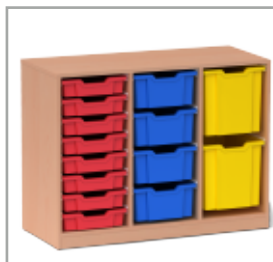

Article No: 147 143814  
8 x F1, 4 x F2, 2 x F3

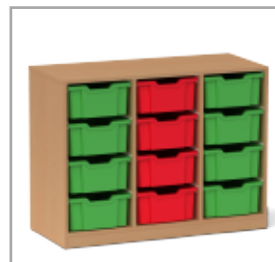

Article No: 147 143820  
12 trays F2



Article No: 147 143830  
6 trays F3



Article no: 147 143870  
8 trays F1



Article No: 147 143872  
4 trays F2



Article No: 147 143880  
16 trays F1



Article No: 147 143882  
8 trays F1, 4 trays F2



Article No: 147 143886  
2 trays F3, 4 trays F2



### Kids chair SAVULEN

Steel frame made of 18mm tube.  
 Polymer powder coating in RAL colours.  
 Seat and backrest made of 7mm beech plywood.  
 Durable plastic glide plugs.  
 Stackable up to 5 pieces.  
 Made in Bulgaria.  
 The product complies with EN 1729 standart.

Article No	Seat size	Size
112 400003	H 35cm, 29x29cm, Size 3	34x36/62cm
112 400002	H 31cm, 28x27cm, Size 2	33x34/56cm
112 400001	H 26cm, 28x27cm, Size 1	33x32/51cm



### Kids chair SAVULEN upholstered

Steel frame made of 18mm tube.  
 Polymer powder coating in RAL colours.  
 Upholstered seat and backrest made of 7mm beech plywood.  
 Durable plastic glide plugs.  
 Stackable up to 5 pieces.  
 Made in Bulgaria.  
 The product complies with EN 1729 standart.

Article No	Seat size	Size
112 400023	H 35cm, 29x29cm, Size 3	34x36/62cm
112 400022	H 31cm, 28x27cm, Size 2	33x34/56cm
112 400021	H 26cm, 28x27cm, Size 1	33x32/51cm



### Kids chair TINA

Kids chair with console, metal frame.  
Easy to place on the table top for easy daily cleaning of the halls.

Steel frame made of 30x15mm oval tube.  
Polymer powder coating in RAL colours.  
Seat and backrest made of 7mm beech plywood.  
Durable plastic glide plugs.  
Stackable up to 4 pieces.  
Made in Bulgaria.  
The product complies with EN 1729 standart.

Article No	Seat size	Size
112 100003	H 35cm, 29x29cm, Size 3	33x34/63cm
112 100002	H 31cm, 28x27cm, Size 2	32x32/57cm
112 100001	H 26cm, 28x27cm, Size 1	32x30/51cm



### Kids chair TINA upholstered

Kids chair with console, metal frame.  
Easy to place on the table top for easy daily cleaning of the halls.

Steel frame made of 30x15mm oval tube.  
Polymer powder coating in RAL colours.  
Upholstered seat and backrest made of 7mm beech plywood.  
Durable plastic glide plugs.  
Stackable up to 4 pieces.  
Made in Bulgaria.  
The product complies with EN 1729 standart.

Article No	Seat size	Size
112 100023	H 35cm, 29x29cm, Размер 3	33x34/63cm
112 100022	H 31cm, 28x27cm, Размер 2	32x32/57cm
112 100021	H 26cm, 28x27cm, Размер 1	32x30/51cm



## Kids modular tables RONDO



Modular kids table with reinforced frame.  
 Countertops size multiples of 60 cm of 18mm laminated chipboard.  
 Rounded edges of the tabletop with 2,0mm edging.  
 Decors for laminated chipboard on page 44.  
 Metal frame with 40mm steel tube legs.  
 Crossbars under the tabletop made of profile 40x20mm.  
 Polymer powder coating in the RAL colors.  
 Durable plastic glide plugs.  
 Made in Bulgaria.  
 The product complies with EN 1729 standart.

Size **3** **2** **1**

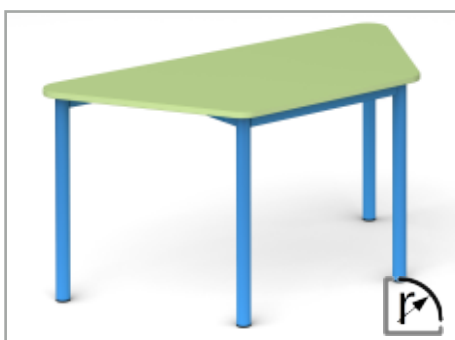

**Modular table RONDO rectangular**

Article No	EN 1729 Size	Tabletop
121 251633	H 59cm, size 3	120x60cm
121 251632	H 53cm, size 2	120x60cm
121 251631	H 46cm, size 1	120x60cm

**Modular Table RONDO trapezoid**

Article No	EN 1729 Size	Tabletop
121 261603	H 59cm, size 3	120x52cm
121 261602	H 53cm, size 2	120x52cm
121 261601	H 46cm, size 1	120x52cm

**Moduler table RONDO semicircle**

Article No	EN 1729 Size	Tabletop
121 281603	H 59cm, size 3	120x60cm
121 281602	H 53cm, size 2	120x60cm
121 281602	H 46cm, size 1	120x60cm

### RONDO 110x55cm



### RONDO 60x60cm



### RONDO Ø80cm



**Table RONDO rectangular 110x55cm**

Articel No	EN 1729 Size	Tabletop
121 251533	H 59cm, size 3	110x55cm
121 251532	H 53cm, size 2	110x55cm
121 251531	H 46cm, size 1	110x55cm

**Modular table RONDO 60x60cm**

Article No	EN 1729 Size	Tabletop
121 241603	H 59cm, Size 3	60x60cm
121 241602	H 53cm, Size 2	60x60cm
121 241601	H 46cm, Size 1	60x60cm

**Table RONDO circle Ø80cm**

Article No	EN 1729 Size	Tabletop
121 270803	H 76cm, size 3	Ø80cm
121 270802	H 71cm, size 2	Ø80cm
121 270801	H 65cm, size 1	Ø80cm

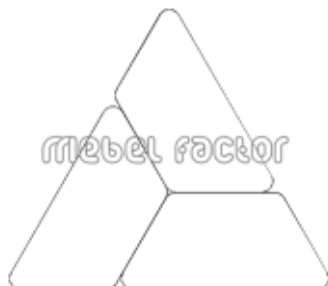

### Kids modular table FLOWER



Combining a circle of 6 pieces with size 140 cm.  
 Tabletop size 69x56cm with 2,0mm edge.  
 Chipboard decors from the company cartel.  
 Welded metal frame with 40mm steel tube legs.  
 Polymer powder coating in the RAL colors.  
 Made in Bulgaria.  
 The product complies with EN 1729 standart.



#### Modular table FLOWER

Article No	EN 1729 Size	Tabletop
121 292003	H 59cm, size 3	69x56cm
121 292002	H 53cm, size 2	69x56cm
121 292001	H 46cm, size 1	69x56cm

### Kids table SAVULEN hexagonal



Hexagonal modular table SAVULEN.  
 Suitable for independent and teamwork.  
 Tabletop size 93x83cm with 2,0mm edge.  
 Chipboard decors from the company cartel.  
 Welded metal frame with 21,3mm steel tube legs.  
 Polymer powder coating in the RAL colors.  
 Made in Bulgaria.

#### Modular table SAVULEN hexagonal

Article No	EN 1729 Size	Tabletop
121 495003	H 59cm, size 3	93x83cm
121 495002	H 53cm, size 2	93x83cm
121 495001	H 46cm, size 1	93x83cm





School modular table DETELINA.  
 Suitable for independent and teamwork.  
 Combining a square of 4 pieces with size 98 cm.  
 Tabletop size 70x47cm with 2,0mm edge.  
 Chipboard decors from the company cartel.  
 Welded metal frame with 40mm steel tube legs.  
 Crossbars under the tabletop made of profile 40x20mm.  
 Polymer powder coating in the RAL colors.  
 Made in Bulgaria.  
 The product complies with EN 1729 standart.

## Kids modular table DETELINA

### Modular table DETELINA

Article No	EN 1729 Size	Tabletop
121 291003	H 59cm, size 3	70x47cm
121 291002	H 53cm, size 2	70x47cm
121 291001	H 46cm, size 1	70x47cm



Possible combinations in a circle:  
 - 3 pcs. with diameter 135cm.  
 - 4 pcs. with diameter 145cm.  
 - 5 pcs. with diameter 160cm.  
 - 6 pcs. with diameter 175cm.  
 Плот с размери 80x60см., кант 2,0мм.  
 Tabletop size 80x60cm with 2,0mm edge.  
 Chipboard decors from the company cartel.  
 Welded metal frame with legs 40mm in diameter.  
 Polymer powder coating in RAL colours.  
 Made in Bulgaria.  
 This product meets the standard EN 1729.

## Kids modular table MARGARITA

### Modular table MARGARITA

Article No	EN 1729 Size	Tabletop
121 293003	H 59cm, size 3	80x60cm
121 293002	H 53cm, size 2	80x60cm
121 293001	H 46cm, size 1	80x60cm



## Kids furniture series HAPPY



Secure furniture for children's playgrounds.  
 Rounded corners on all front details.  
 Countertops and elements made of 18mm laminated chipboard.  
 Edge 2,0mm for all rounded elements.  
 Double secured joints for stability.  
 Decors of chipboard from the company cartel.  
 Made in Bulgaria.



**Kids table HAPPY 120x60 cm.**  
 Article No EN1729 Size Tabletop  
 121 551632 H53cm, size 2 120x60cm.



**Kids table HAPPY 60x60 cm.**  
 Article No EN1729 Size Tabletop  
 121 541602 H53cm, size 2 60x60cm.



**Kids table HAPPY diameter Ø80 cm.**  
 Article No EN1729 Size Tabletop  
 121 570802 H53cm, size 2 Ø80 cm.



**Kids bench HAPPY 85x30 cm.**  
 Article No Seat Size  
 115 520852 H 30cm, size 2 85x36cm



**Kids chair HAPPY**  
 Article No Seat Size  
 112 530002 H 30cm, size 2 36x36cm



**Kids table HAPPY diameter Ø60 cm.**  
 Article No EN1729 Size Tabletop  
 121 570602 H53cm, size 2 Ø60 cm.



**Kids bench HAPPY 90x30 cm.**  
 Article No Seat Size  
 115 530902 H 30cm, size 2 90x30cm

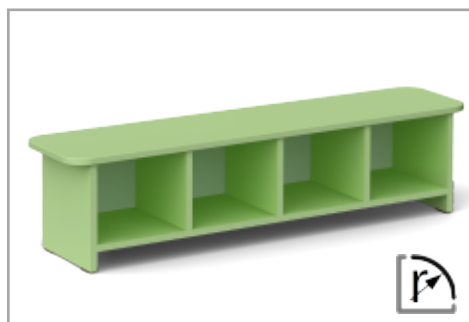

**Kids bench 120x30 cm.**  
 Article No Seat Size  
 115 541202 H 30cm, size 2 120x30cm

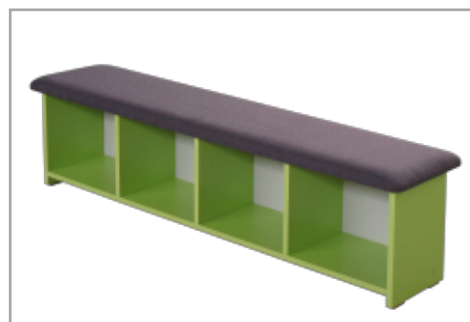

**Upholstered bench HAPPY 120x30 cm.**  
 Артикул Седалка Размери  
 115 541212 H 30cm, size 2 120x30cm



## Kids bench with backrest SAVULEN



Размер **4 3 2 1**

Colorful kids bench Savulen with metal frame.  
Heights suitable for children aged 3 to 10 years.

Seat and backrest made of 18mm chipboard.  
Rounded edges of the seat and backrest with 2mm edging.  
Chipboard decors from the company cartel.  
Welded metal frame made of 21,3mm tube.  
Polymer powder coating in RAL colours.  
Durable plastic glide plugs.  
Made in Bulgaria.  
The product complies with EN 1729 standart.



**Benck with backrest SAVULEN 120 cm.**

Article No	Seat	Size
115 431204	H 38cm, size 4	120x44cm
115 431203	H 35cm, size 3	120x42cm
115 431202	H 31cm, size 2	120x41cm
115 431201	H 26cm, size 1	120x40cm

**Benck with backrest SAVULEN 150 cm.**

Article No	Seat	Size
115 431504	H 38cm, size 4	150x44cm
115 431503	H 35cm, size 3	150x42cm
115 431502	H 31cm, size 2	150x41cm
115 431501	H 26cm, size 1	150x40cm

**Benck with backrest SAVULEN 180 cm.**

Article No	Seat	Size
115 431804	H 38cm, size 4	180x44cm
115 431803	H 35cm, size 3	180x42cm
115 431802	H 31cm, size 2	180x41cm
115 431801	H 26cm, size 1	180x40cm



Размер **4 3 2 1**

## Kids bench with backrest SAVULEN upholstered

Colorful kids bench Savulen with metal frame.  
Heights suitable for children aged 3 to 10 years.

Upholstered seat and backrest made of 18mm chipboard.  
Patterns for fabrics and leather from the company cartel.  
Welded metal frame made of 21,3mm tube.  
Polymer powder coating in RAL colours.  
Durable plastic glide plugs.  
Made in Bulgaria.  
The product complies with EN 1729 standart.



**Upholstered bench SAVULEN 120 cm.**

Article No	Seat	Size
115 441204	H 38cm, size 4	120x44cm
115 441203	H 35cm, size 3	120x42cm
115 441202	H 31cm, size 2	120x41cm
115 441201	H 26cm, size 1	120x40cm

**Upholstered bench SAVULEN 150 cm.**

Article No	Seat	Size
115 441504	H 38cm, size 4	150x44cm
115 441503	H 35cm, size 3	150x42cm
115 441502	H 31cm, size 2	150x41cm
115 441501	H 26cm, size 1	150x40cm

**Upholstered bench SAVULEN 180 cm.**

Article No	Seat	Size
115 441804	H 38cm, size 4	180x44cm
115 441803	H 35cm, size 3	180x42cm
115 441802	H 31cm, size 2	180x41cm
115 441801	H 26cm, size 1	180x40cm

## Kids bench SAVULEN

Colorful kids bench Savulen with metal frame.  
Stacking up to 5 pieces. Convenient for quick arrangement.  
Heights suitable for children aged 3 to 10 years.

Seat made of 18mm chipboard.  
Rounded edges of the seat and backrest with 2mm edging.  
Chipboard decors from the company cartel.  
Welded metal frame made of 21,3mm tube.  
Polymer powder coating in RAL colours.  
Durable plastic glide plugs.  
Made in Bulgaria.  
The product complies with EN 1729 standart.

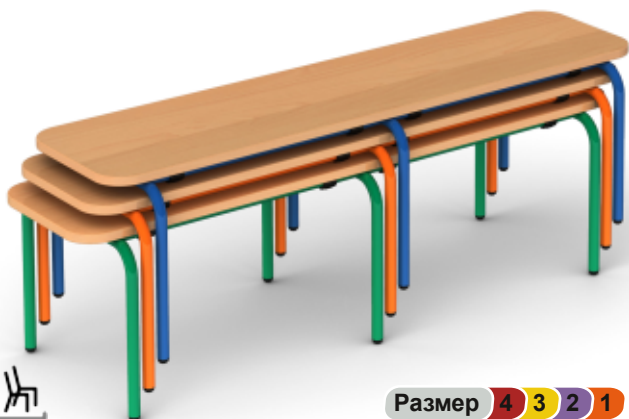

Размер **4 3 2 1**

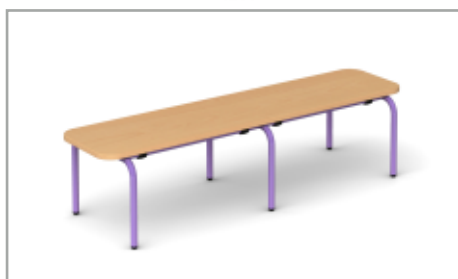

Bench SAVULEN 120 cm.

Article No	Seat	Size
115 411204	H 38cm, size 4	120x39cm
115 411203	H 35cm, size 3	120x37cm
115 411202	H 31cm, size 2	120x36cm
115 411201	H 26cm, size 1	120x35cm

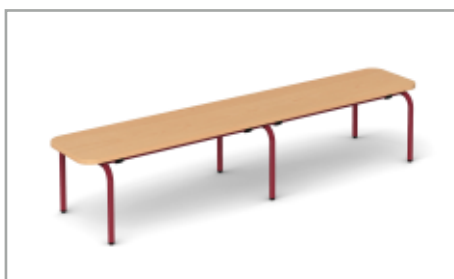

Bench SAVULEN 150 cm.

Article No	Seat	Size
115 411504	H 38cm, size 4	150x39cm
115 411503	H 35cm, size 3	150x37cm
115 411502	H 31cm, size 2	150x36cm
115 411501	H 26cm, size 1	150x35cm

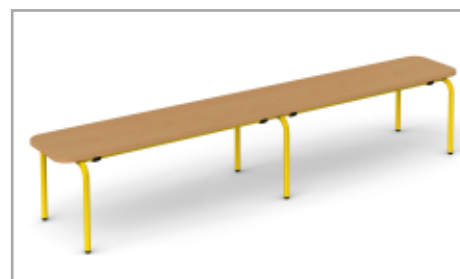

Bench SAVULEN 180 cm.

Article No	Seat	Size
115 411804	H 38cm, size 4	180x39cm
115 411803	H 35cm, size 3	180x37cm
115 411802	H 31cm, size 2	180x36cm
115 411801	H 26cm, size 1	180x35cm

## Kids bench SAVULEN upholstered

Colorful kids bench Savulen with metal frame.  
Stacking up to 5 pieces. Convenient for quick arrangement.  
Heights suitable for children aged 3 to 10 years.

Upholstered seat made of 18mm chipboard.  
Patterns for fabrics and leather from the company cartel.  
Welded metal frame made of 21,3mm tube.  
Polymer powder coating in RAL colours.  
Durable plastic glide plugs.  
Made in Bulgaria.  
The product complies with EN 1729 standart.



Размер **4 3 2 1**



Upholstered bench SAVULEN 120 cm.

Article No	Seat	Size
115 421204	H 38cm, size 4	120x39cm
115 421203	H 35cm, size 3	120x37cm
115 421202	H 31cm, size 2	120x36cm
115 421201	H 26cm, size 1	120x35cm

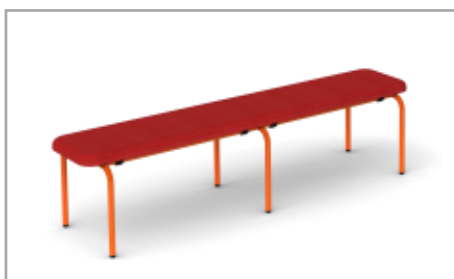

Upholstered bench SAVULEN 150 cm.

Article No	Seat	Size
115 421504	H 38cm, size 4	150x39cm
115 421503	H 35cm, size 3	150x37cm
115 421502	H 31cm, size 2	150x36cm
115 421501	H 26cm, size 1	150x35cm

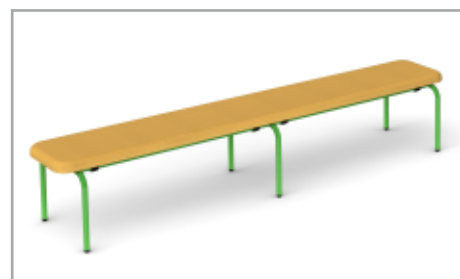

Upholstered bench SAVULEN 180 cm.

Article No	Seat	Size
115 421804	H 38cm, size 4	180x39cm
115 421803	H 35cm, size 3	180x37cm
115 421802	H 31cm, size 2	180x36cm
115 421801	H 26cm, size 1	180x35cm

Kids modular furniture with secure corners

Single shelves and cupboards 42x39/H86,5cm



Code: 143 635200 Code: 143 631200 Code: 143 631212 Code: 143 631251

Code: 143 632200

Single shelves and cupboards 42x39/H119,5cm

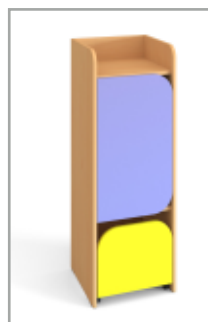
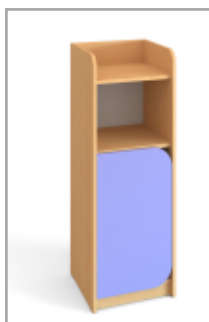

Code: 143 635300 Code: 143 631300 Code: 143 631312 Code: 143 631351 Code: 143 631362

Code: 143 632300

Single shelves and cupboards 42x39/H152,5cm

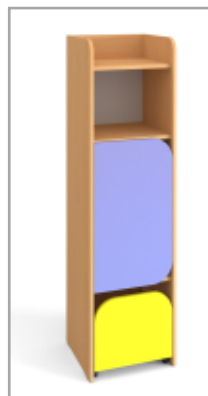
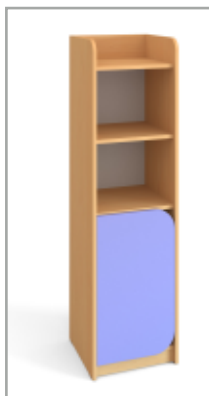

Code: 143 635400 Code: 143 631400 Code: 143 631412 Code: 143 631451 Code: 143 631462

Code: 143 632400



Kids modular furniture with secure corners

Double shelves and cupboards 80x38/H86,5cm



Code: 143 632232



Code: 143 632252



Code: 143 632254

Secure kids modular furniture.  
 Rounded corners of all facial details.  
 Doors and drawers without protruding handles.  
 Drawers with wheels for full withdrawal.  
 Distance between shelves 31 cm.  
 Housing and shelves of 18mm laminated chipboard.  
 Back of laminated HDF 3 mm.  
 Decors of chipboard from the company cartel.  
 Made in Bulgaria.

Double shelves and cupboards 80x39/H119,5cm



Code: 143 632332



Code: 143 632352



Code: 143 632354

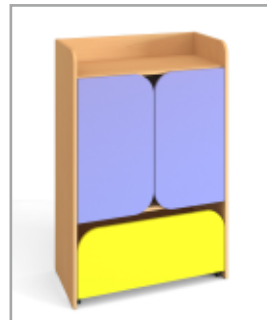

Code: 143 632362

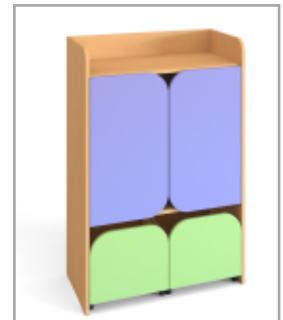

Code: 143 632364

Double shelves and cupboards 80x39/H152,5cm

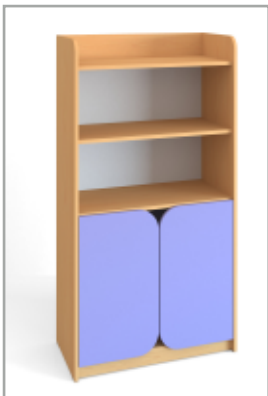

Code: 143 632432



Code: 143 632452



Code: 143 632454

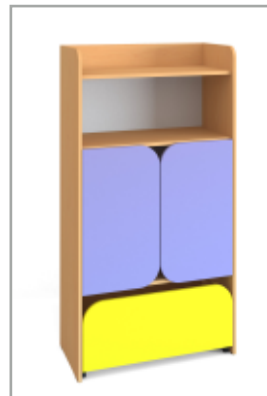

Code: 143 632462

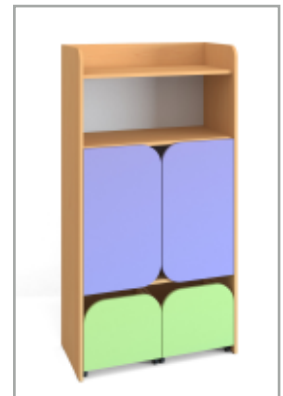

Code: 143 632464



Kindergarten wardrobes with full length doors



Wardrobe with two wings  
Article No 146 3324B4      Size 59x37/H130cm

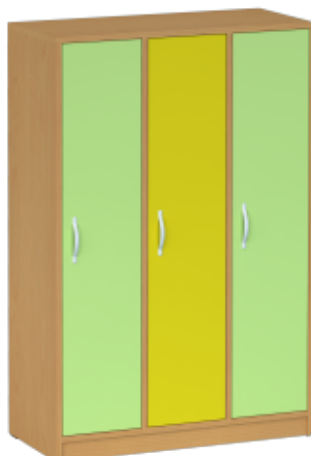

Wardrobe with three wings  
Article No 146 3334B4      Size 87x37/H130cm

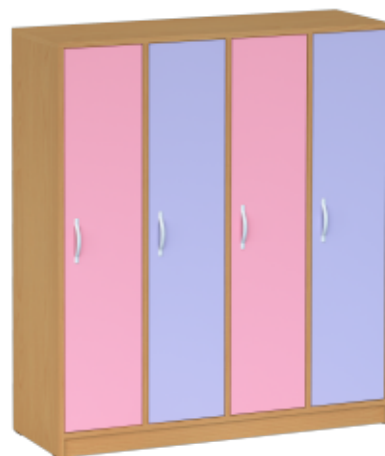

Wardrobe with four wings  
Article No 146 3344B4      Size 115x37/H130cm

Kindergarten wardrobes with open shoe shelf



Wardrobe with two wings  
Article No 146 3324B3      Size 59x37/H130cm



Wardrobe with three wings  
Article No 146 3334B3      Size 87x37/H130cm

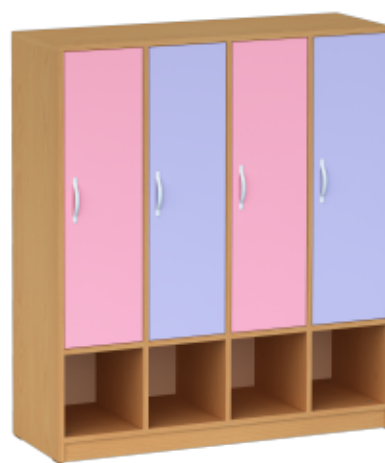

Wardrobe with four wings  
Article No 146 3344B3      Size 115x37/H130cm

Kindergarten wardrobes with seating area and open shoe shelf



Wardrobe with two wings  
Article No 146 3724B3      Size 59x60/H130cm



Wardrobe with three wings  
Article No 146 3734B3      Size 87x60/H130cm



Wardrobe with four wings  
Article No 146 3744B3      Size 115x60/H130cm

## Kindergarten beds

Beds for kindergartens with rounded safety corners.  
 Housing made of laminated chipboard 18mm with edging 2,0 mm.  
 Decors of chipboard from the company cartel.  
 Mattresses are not included in the price of beds.  
 Made in Bulgaria.



**Kids bunk bed**

Article No	Mattress	Size
163 821260	120x60cm	128x80/H135cm
163 821470	140x70cm	148x90/H135cm

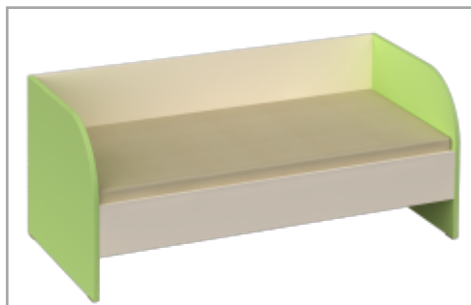

**Kids bed with two headboards and back**

Article No	Mattress	Size
163 101260	120x60cm	124x64/H53cm
163 101470	140x70cm	144x74/H53cm

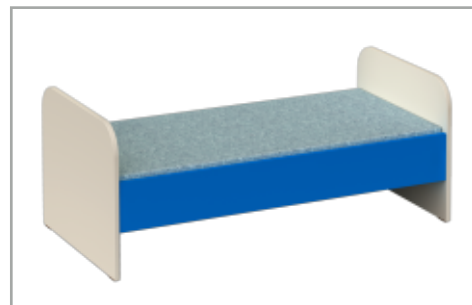

**Kids bed with two high headboards**

Article No	Mattress	Size
163 211260	120x60cm	124x64/H53cm
163 211470	140x70cm	144x74/H53cm



**Kids bed with headboard and back, left**

Article No	Mattress	Size
163 101262	120x60cm	124x64/H53cm
163 101472	140x70cm	144x74/H53cm



**Kids bed with headboard and back, right**

Article No	Mattress	Size
163 101261	120x60cm	124x64/H53cm
163 101471	140x70cm	144x74/H53cm

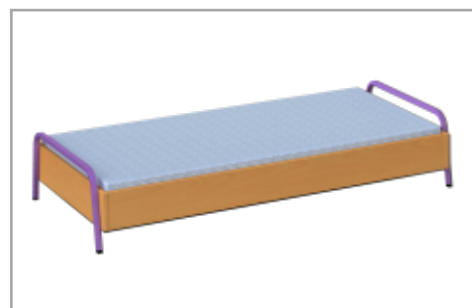

**Stackable kids bed with metal legs**

Article No	Mattress	Size
163 321260	120x60cm	126x64/H29cm
163 321470	140x70cm	146x84/H29cm

## Sandwich beds

Beds for kindergartens with limited space.  
 Fixed upper bed and lower beds with special pull-out wheels.  
 Decors of chipboard from the company cartel.  
 Mattresses are not included in the price of the beds.  
 Made in Bulgaria.



**Two-story sandwich bed**

Article No	Mattress	Size
163 221260	120x60cm	125x65/H60cm
163 221470	140x70cm	145x75/H60cm



**Three-story sandwich bed**

Article No	Mattress	Size
163 231260	120x60cm	125x65/H83cm
163 231470	140x70cm	145x75/H83cm

## Stackable beds

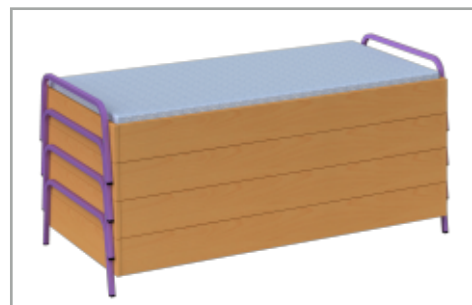
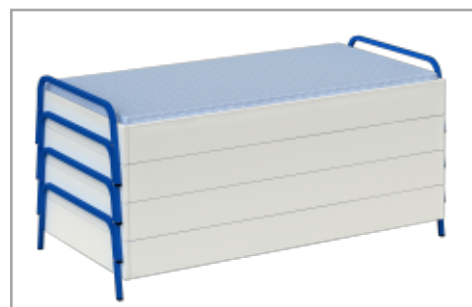



## Dining tables series RONDO

Dining tables with reinforced frame  
Options with a rectangular top or rounded corners.  
Additional option for leveling steps.

Tabletop made of 18mm laminated chipboard with 2,00mm edging.  
Frame with steel tube legs Ø40mm.  
Crossbars under the tabletop made of rectangular profile 40x20mm.  
Polymer, powder coating in RAL colors.  
Wear-resistant, plastic steps.  
Made in Bulgaria.



### Round table RONDO

Article No	EN 1729 Size	Tabletop
120 270806	H 76cm, size 6	Ø80cm
120 270906	H 76cm, size 6	Ø90cm
120 271206	H 76cm, size 6	Ø120cm

### Square table RONDO

Article No	EN 1729 Size	Tabletop
120 240706	H 76cm, size 6	70x70cm
120 240806	H 76cm, size 6	80x80cm
120 240906	H 76cm, size 6	90x90cm

**Option for rounded corners of the tabletop**

120 241706	H 76cm, size 6	70x70cm
120 241806	H 76cm, size 6	80x80cm
120 241906	H 76cm, size 6	90x90cm

### Rectangular table RONDO

Article No	EN 1729 Size	Tabletop
120 250736	H 76cm, size 6	120x70cm
120 250746	H 76cm, size 6	140x70cm
120 250846	H 76cm, size 6	140x80cm
120 250866	H 76cm, size 6	160x80cm

**Option for rounded corners of the tabletop**

120 251736	H 76cm, size 6	120x70cm
120 251746	H 76cm, size 6	140x70cm
120 251846	H 76cm, size 6	140x80cm
120 251866	H 76cm, size 6	160x80cm

## Dining tables series SAVULEN



### Round table SAVULEN

Article No	EN 1729 Size	Tabletop
120 470806	H 76cm, size 6	Ø80cm
120 470906	H 76cm, size 6	Ø90cm
120 471206	H 76cm, size 6	Ø120cm

### Square table SAVULEN

Article No	EN 1729 Size	Tabletop
120 440706	H 76cm, size 6	70x70cm
120 440806	H 76cm, size 6	80x80cm
120 440906	H 76cm, size 6	90x90cm

**Option for rounded corners of the tabletop**

120 441706	H 76cm, size 6	70x70cm
120 441806	H 76cm, size 6	80x80cm
120 441906	H 76cm, size 6	90x90cm

### Rectangular table SAVULEN

Article No	EN 1729 Size	Tabletop
120 450736	H 76cm, size 6	120x70cm
120 450746	H 76cm, size 6	140x70cm
120 450846	H 76cm, size 6	140x80cm

**Option for rounded corners of the tabletop**

120 451736	H 76cm, size 6	120x70cm
120 451746	H 76cm, size 6	140x70cm
120 451846	H 76cm, size 6	140x80cm

Laminated chipboard tabletop 18mm.  
Metal frame made of steel tube Ø21,3mm.  
Made in Bulgaria.

## Tables series STYLE

Еlegantна маса с масивен централен крак.  
Варианти с правоъгълен плот или заоблени ъгли.

Плот от ламинирано ПДЧ 18мм с кант 2мм.  
Конструкция с крака от стоманена тръба Ø76мм.

База от листова стомана с дебелина 8мм.  
Полимерно, прахово покритие в цветове по система RAL.  
Произведено в България.



### Table STYLE rectangular

Article No	Size
120 150736	120x70/H75cm
120 150746	140x70/H75cm
120 150846	140x80/H75cm

### Rounded corners of the tabletop

Article No	Size
120 151736	120x70/H75cm
120 151746	140x70/H75cm
120 151846	140x80/H75cm

## STYLE square



### Table STYLE square

Article No	Size
120 140706	70x70/H75cm
120 140806	80x80/H75cm
120 140906	90x90/H75cm

### Rounded corners of the tabletop

120 141706	70x70/H75cm
120 141806	80x80/H75cm
120 141906	90x90/H75cm

## STYLE round



### Table STYLE round

Article No	Size
120 170706	Ø70/H75cm
120 170806	Ø80/H75cm
120 170906	Ø90/H75cm

## Serving trolleys



### Trolleys with metal shelves.

Wheels with 75mm diameter.  
Two wheels with lock.  
RAL powder coating.  
Made in Bulgaria.

### Trolley with two metal shelves

Article No	Size
161 128445	84x45/H80cm



### Trolleys with chipboard shelves.

Wheels with 75mm diameter.  
Two wheels with lock.  
RAL powder coating.  
Made in Bulgaria.

### Trolley with two shelves

Article No	Size
161 228445	84x45/H80cm



### Trolley with three metal shelves

Article No	Size
161 138445	84x45/H80cm



### Trolley with three shelves

Article No	Size
161 238445	84x45/H80cm



# Household furniture / Chairs



**Chair PRIMA**  
Article No 110 030010      Size 46x48/H87cm



**Chair PRESTIGE**  
Article No 113 050012      Size 44x56/H85cm



**Chair LYRA**  
Article No 110 040022      Size 44x46/H82cm



**Chair MIRA**  
Article No 110 020075      Size 44x45/H86cm



**Stool TUIDA**  
Article No 114 010010      Size 40x40/H43cm



**Stool TUIDA upholstered**  
Article No 114 010011      Size 40x40/H44cm



**Barstool TUIDA STIF**  
Article No 114 011010      Size 48x48/H70cm



**Barstool TUIDA STIF upholstered**  
Article No 114 011011      Size 48x48/H70cm

## Chairs and stools



## Barstools



**Barstool TUIDA**  
Article No 113 010011      Size 42x42/H75cm



**Barstool LOTUS**  
Article No 113 020011      Size 44x44/H75cm



### Double-sided, decorative shelves CUBE

Spectacular shelf suitable for decorative partition.  
 Housing and shelves made of 18mm chipboard with 0.5mm edging.  
 Decors of chipboard from the company cartel.

Leveling steps.  
 Made in Bulgaria.



**Combination CUBE 421K30**  
**Article No**      **Size**  
 140 421K30    147x50/H179cm



**CUBE three**  
 140 421300  
 35x35/H109cm



**CUBE four**  
 140 421400  
 35x35/H144cm



**CUBE five**  
 140 421500  
 35x35/H179cm

### Double-sided, decorative shelves STAIRS

Spectacular shelf for wall and central placement.  
 Housing and shelves made of 18 mm chipboard with 0.5 mm edging.  
 Decors of chipboard from the company cartel.

Leveling steps  
 Made in Bulgaria.



**Shelve STAIRS 3x4**  
**Article No**      **Size**  
 140 423400    102x35/H144cm



**Shelve STAIRS right**  
**Article No**      **Size**  
 140 423301    102x35/H110cm



**Shelve STAIRS left**  
**Article No**      **Size**  
 140 423302    102x35/H110cm

## Benches for gyms

For gyms with intensive use.  
Option for leveling steps.  
Solid wood seat.  
Frame with legs made of Ø40mm tube.  
Crossbars from a rectangular tube 40x20mm.  
Metal hangers for bags and clothes.  
Powder coating in RAL colors.  
Wear-resistant, plastic steps.  
Made in Bulgaria.

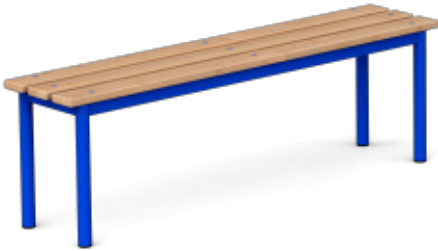

**Bench for gyms**

Article No	Size	Seat
115 211506	150x32/H45cm	H45cm



**One-sided locker room bench**

Article No	Size	Seat
115 241506	150x41/H160cm	H45cm



**Two-sided locker room bench**

Article No	Size	Seat
115 261506	150x78/H160cm	H45cm

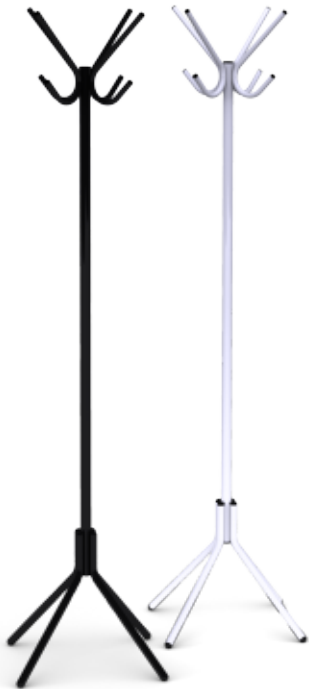

**Standing hanger 010002**

Article No	Size
168 010002	41x41/H178cm

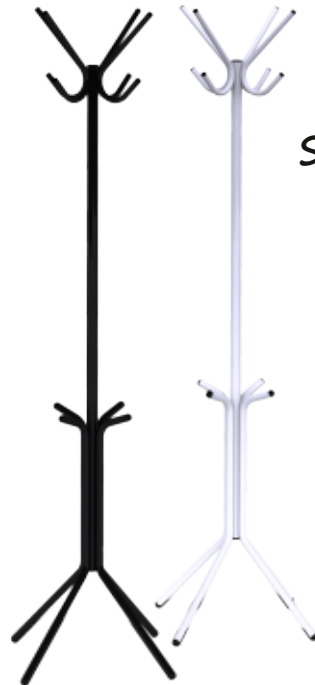

**Standing hanger 010004**

Article No	Size
168 010004	41x41/H178cm

## Standing hangers

## Wall hanger PUZZLE

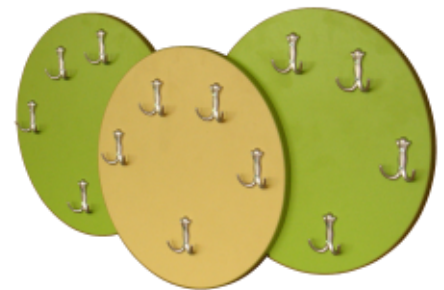

**Wall hanger PUZZLE**

Article No	Size
168 080010	41x41/H178cm

## Wall hangers and panels



**Wall hanger 14 hooks**

Article No	Size
168 100168	168x25cm



**Wall hanger 10 hooks**

Article No	Size
168 100120	120x25cm



**Wall protector**

Article No	Size
168 099120	120x25cm



### Wardrobes

Wardrobes for clothes and personal belongings.  
 Housing and doors made of 18mm chipboard.  
 Edge 2,0mm for the doors and 0,5mm for the body.  
 Two built-in shelves. Metal traverse for hangers.  
 Doors with reinforced installation on three hinges.  
 Option for placing locks.  
 3mm laminated HDF back.  
 Decors of chipboard from the company cartel.  
 Made in Bulgaria.

**Single wing wardrobe**

<b>Article No</b>	<b>Size</b>
145 161301	40x55/H190cm

**Double wing wardrobe**

<b>Article No</b>	<b>Size</b>
145 162301	80x55/H190cm

### Wardrobes for work clothes and personal belongings

Cabinets for work clothes and personal belongings. Housing and doors made of 18mm laminated chipboard. Edge 2,0mm for the doors and 0,5 mm for the body. Two built-in shelves. Doors with reinforced installation on three hinges. Option for placing locks. 3mm laminated HDF back. Decors of chipboard from the company cartel. Made in Bulgaria.



**Single wing wardrobe**

<b>Article No</b>	<b>Size</b>
145 131301	40x37/H190cm

**Double wing wardrobe**

<b>Article No</b>	<b>Size</b>
145 132301	78x37/H190cm

**Triple wing wardrobe**

<b>Article No</b>	<b>Size</b>
145 133301	117x37/H190cm



## Office Module CLASSIC

Metal frame from a rectangular profile 50x30mm.  
 Two reinforcing bars under the tabletop 50x30mm profile.  
 Easy combinations for creating many office configurations.  
 Leveling screw steps.  
 Tabletop from 18mm laminated chipboard, 2mm edging.  
 Decors for the chipboard from the company cartel.  
 Polymer dust finish in RAL colours.  
 Made in Bulgaria.

### CLASSIC desks



#### CLASSIC Primary Desk

Article No	Dimensions
130 208180	180x80/H75cm
130 208160	160x80/H75cm
130 207180	180x70/H75cm
130 207160	160x70/H75cm
130 207140	140x70/H75cm
130 207120	120x70/H75cm

#### CLASSIC Extra Desk

Article No	Dimensions
130 205120	120x50/H75cm
130 205100	100x50/H75cm

### CLASSIC desk with front



#### CLASSIC Primary Desk with Front

Article No	Dimensions
130 208181	180x80/H75cm
130 208161	160x80/H75cm
130 207181	180x70/H75cm
130 207161	160x70/H75cm
130 207141	140x70/H75cm
130 207121	120x70/H75cm

#### CLASSIC Extra Desk with front

Article No	Dimensions
130 205121	120x50/H75cm
130 205101	100x50/H75cm

### CLASSIC Addon desk



#### CLASSIC Additional Desk

Article No	Dimensions
130 215120	120x50/H75cm
130 215100	100x50/H75cm

#### CLASSIC Additional Desk with front

Article No	Dimensions
130 215121	120x50/H75cm
130 215101	100x50/H75cm





## Office Module ELITE

Metal frame from a rectangular profile 50x30mm.  
 Two reinforcing bars under the tabletop 50x30mm profile.  
 Easy combinations for creating many office configurations.  
 Leveling screw steps.  
 Tabletop from 18mm laminated chipboard, 2mm edging.  
 Decors for the chipboard from the company cartel.  
 Polymer dust finish in RAL colours.  
 Made in Bulgaria.

### ELITE desks



#### ELITE Primary Desk

Article No	Dimensions
130 308180	180x80/H75cm
130 308160	160x80/H75cm
130 307180	180x70/H75cm
130 307160	160x70/H75cm
130 307140	140x70/H75cm
130 307120	120x70/H75cm

#### Extra desk ELITE

Article No	Dimensions
130 305120	120x50/H75cm
130 305100	100x50/H75cm

### ELITE desk with front



#### ELITE Primary Desk with front

Article No	Dimensions
130 308181	180x80/H75cm
130 308161	160x80/H75cm
130 307181	180x70/H75cm
130 307161	160x70/H75cm
130 307141	140x70/H75cm
130 307121	120x70/H75cm

#### ELITE Extra Desk with front

Article No	Dimensions
130 305121	120x50/H75cm
130 305101	100x50/H75cm

### ELITE Additional desk



#### ELITE Additional Desk

Article No	Dimensions
130 315120	120x50/H75cm
130 315100	100x50/H75cm

#### ELITE Additional Desk with front

Article No	Dimensions
130 315121	120x50/H75cm
130 315101	100x50/H75cm





## Office Module ELEGANT

Metal frame from a rectangular profile 50x30mm.  
 Two reinforcing bars under the tabletop made of 50x30mm profile.  
 Easy to combine in many office configurations.  
 Adjustable plastic steps with metal thread.  
 Tabletop made from 18mm laminated chipboard with 2,0mm edging.  
 Decors for the chipboard from the company cartel.  
 Polymer dust finish in RAL colours.  
 Made in Bulgaria.

### ELEGANT Desk



**ELEGANT Primary Desk**

Article no	Dimensions
130 408180	180x80/H75cm
130 408160	160x80/H75cm
130 407180	180x70/H75cm
130 407160	160x70/H75cm
130 407140	140x70/H75cm
130 407120	120x70/H75cm

**ELEGANT Extra Desk**

Article No	Dimensions
130 405120	120x50/H75cm
130 405100	100x50/H75cm

### ELEGANT Desk with front



**ELEGANT Primary Desk with front**

Article	Dimensions
130 408181	180x80/H75cm
130 408161	160x80/H75cm
130 407181	180x70/H75cm
130 407161	160x70/H75cm
130 407141	140x70/H75cm
130 407121	120x70/H75cm

**ELEGANT Extra Desk with front**

Article No	Dimensions
130 405121	120x50/H75cm
130 405101	100x50/H75cm

### ELEGANT Addon Desk



**ELEGANT Additional Desk**

Article No	Dimensions
130 415120	120x50/H75cm
130 415100	100x50/H75cm

**ELEGANT Additional Desk with front**

Article No	Dimensions
130 415121	120x50/H75cm
130 415101	100x50/H75cm



### Mobile Office Pedestals



**Mobile Office Pedestal with a cabinet**  
**Article No** 134 112612      **Dimensions** 42x50/H58cm



**Mobile Office Pedestal with a cabinet and drawer**  
**Article No** 134 112632      **Dimensions** 42x50/H58cm



**Mobile Office Pedestal with three drawers**  
**Article No** 134 112662      **Dimensions** 42x50/H58cm



**Mobile Office Pedestal with four drawers**  
**Article No** 134 112672      **Dimensions** 42x50/H58cm



### Connecting Sector

**Corner Modules**  
**Article No**      **Dimensions**  
 131 225701      70x50/H75cm  
 131 225801      80x50/H75cm  
 131 227801      80x70/H75cm  
 131 227701      70x70/H75cm  
 131 228801      80x80/H75cm

### Computer Shelf

**Computer Shelf**  
**Article No** 131 290050      **Dimensions** 22x45/H50cm

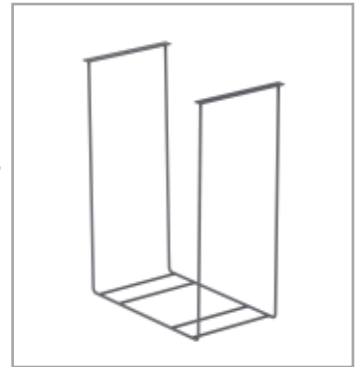



### COMPACT Desks



COMPACT desk with a cabinet and drawer.  
 Dimensions of the desk 120x60cm/H76cm.  
 Made out of laminated chipboard 18mm.  
 Tabletop 120x60cm with 2mm edges.  
 Decors for laminated chipboard from the company cartel.  
 Made in Bulgaria.

**COMPACT with a cabinet and drawer**

<b>Article No</b>	<b>Dimensions</b>
132 135032	120x60H76cm



<b>COMPACT Desk</b>	
<b>Article No</b>	<b>Dimensions</b>
132 135000	120x60H76cm



<b>COMPACT desk with a cabinet</b>	
<b>Article No</b>	<b>Dimensions</b>
132 135012	120x60H76cm



<b>COMPACT with a cabinet and shelf</b>	
<b>Article</b>	<b>Dimensions</b>
132 135022	120x60H76cm



<b>COMPACT with three drawers</b>	
<b>Article No</b>	<b>Dimensions</b>
132 135062	120x60H76cm

### TINA Desks



TINA desk with a cabinet and drawer.  
 Dimensions of the desk 120x60cm/H76cm.  
 Made out of laminated chipboard 18mm.  
 Tabletop 120x60cm with 2mm edges.  
 Decors for laminated chipboard from the company cartel.  
 Made in Bulgaria.

**TINA with a cabinet and drawer**

<b>Article No</b>	<b>Dimensions</b>
132 235032	120x60H76cm



<b>TINA Desk</b>	
<b>Article No</b>	<b>Dimensions</b>
132 235000	120x60H76cm



<b>TINA Desk with a cabinet</b>	
<b>Article No</b>	<b>Dimensions</b>
132 235012	120x60H76cm



<b>TINA Desk with a cabinet and shelf</b>	
<b>Article No</b>	<b>Dimensions</b>
132 235022	120x60H76cm



<b>TINA Desk with three drawers</b>	
<b>Article No</b>	<b>Dimensions</b>
132 235062	120x60H76cm

### COMPACT Computer Desks



COMPACT desk with a cabinet and drawer.  
 Dimensions of the desk 140x60cm/H76cm.  
 Made out of laminated chipboard 18mm.  
 Tabletop 140x60cm with 2mm edges.  
 Retractable keyboard shelf.  
 Decors for laminated chipboard from the company cartel.  
 Made in Bulgaria.

**COMPACT with a cabinet and drawer**  
**Article No**            **Dimensions**  
 135 136056            140x60H76cm



**COMPACT Computer Desk**  
**Article No**            **Dimensions**  
 135 136000            140x60H76cm



**COMPACT Desk with cabinet**  
**Article No**            **Dimensions**  
 135 136016            140x60H76cm



**COMPACT with cabinet and shelf**  
**Article No**            **Dimensions**  
 135 136026            140x60H76cm



**COMPACT with three drawers**  
**Article No**            **Dimensions**  
 135 136066            140x60H76cm

### TINA Computer Desks



TINA desk with a cabinet and drawer.  
 Dimensions of the desk 140x60cm/H76cm.  
 Made out of laminated chipboard 18mm.  
 Tabletop 140x60cm with 2mm edges.  
 Retractable keyboard shelf.  
 Decors for laminated chipboard from the company cartel.  
 Made in Bulgaria.

**TINA with a cabinet and drawer**  
**Article No**            **Dimensions**  
 132 235032            120x60H76cm



**TINA Computer Desk**  
**Article No**            **Dimensions**  
 135 236000            140x60H76cm



**TINA Desk with a cabinet**  
**Article No**            **Dimensions**  
 135 236016            140x60H76cm



**TINA with a cabinet and shelf**  
**Article No**            **Dimensions**  
 135 236026            140x60H76cm



**TINA with three drawers**  
**Article No**            **Dimensions**  
 135 236066            140x60H76cm

*Conference table SOFT*

Tabletop with a thickness of 36mm made of laminated chipboard 18mm. Two-color tabletop and body. Decors of chipboard from the company cartel. Made in Bulgaria.



**Conference table SOFT**  
**Article No**                      **Size**  
 127 011218                      210x80H75cm  
 127 011219                      210x90H75cm

*Conference table SOFT oval*



**Conference table SOFT oval**  
**Article No**                      **Size**  
 127 012219                      210x90H75cm

*Modular conference table POLLY*

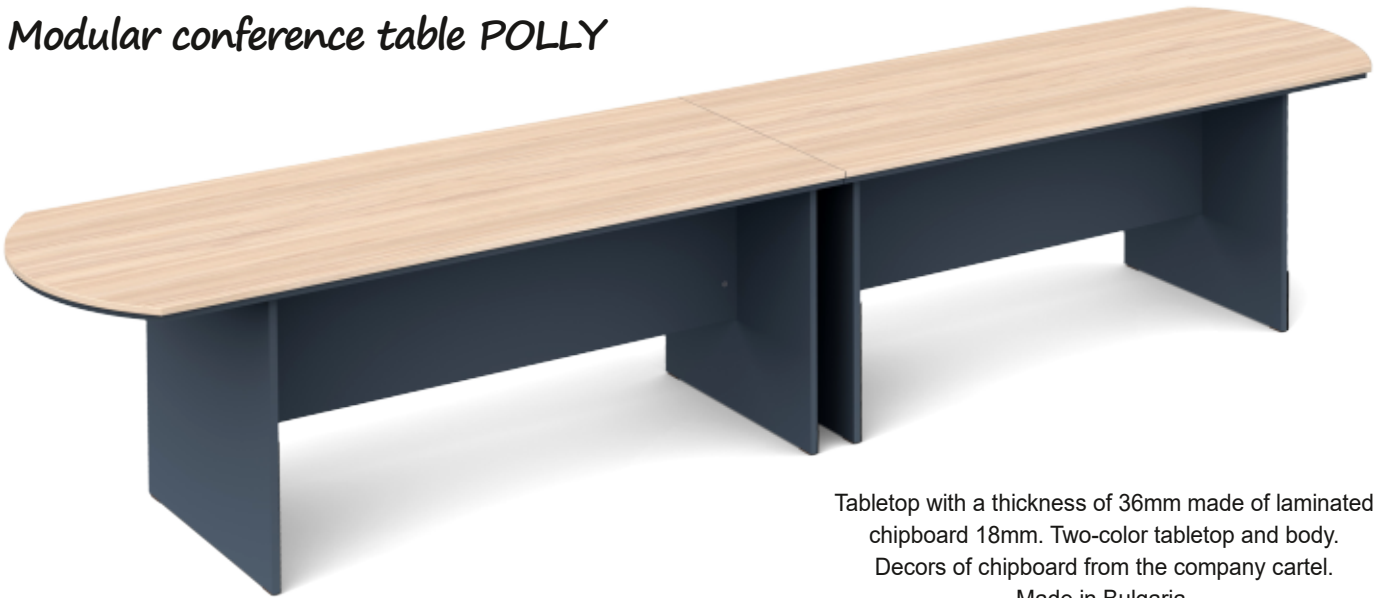

Tabletop with a thickness of 36mm made of laminated chipboard 18mm. Two-color tabletop and body. Decors of chipboard from the company cartel. Made in Bulgaria.

*Table POLLY end module*



**Conference table POLLY end module**  
**Article No**                      **Size**  
 127 022188                      180x80H75cm  
 127 022189                      180x90H75cm  
 127 022182                      180x120H75cm

*Table POLY middle module*



**Conference table POLLY middle module**  
**Article No**                      **Size**  
 127 021168                      160x80H75cm  
 127 021169                      160x90H75cm  
 127 021162                      160x120H75cm

Conference table *RONDO STIF* series



Stacking table with reinforced construction.  
 Convenient for quick rearrangement of any room.  
 Additional option for leveling steps.  
 Laminated chipboard tabletop 18mm with edging 2,0mm.  
 Metal frame with steel tube legs Ø40mm.  
 Crossbars made of rectangular profile 40x20mm.  
 Powder coating in RAL colors.  
 Wear-resistant, plastic steps.  
 Made in Bulgaria.



**Article No** 127 210656    **Size** 79x50/H76cm    **Tabletop** 70x50cm



Single and double conference tables *RONDO STIF*



**Article No** 127 220656    **Size** 129x50/H76cm    **Tabletop** 120x50cm



Stacking up to 4 pieces



*Single office cupboards and bookcases*

*Single office cupboards and bookcases H81cm.*



Code: 140 135200



Code: 140 131200



Code: 140 131212

*Triple shelf  
for office equipment*

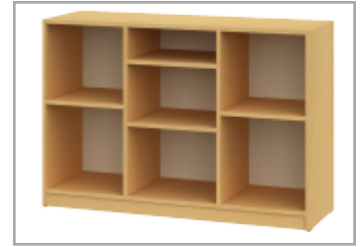

Code: 140 133200

*Single office cupboards and bookcases H117cm.*



Code: 140 135300



Code: 140 131300



Code: 140 131312



Code: 140 131313

Modular furniture with various levels.  
Space between shelves 34 cm.  
Body and shelves of 18mm chipboard.  
Doors with quality hinges.  
Option for placing locks.  
Back of laminated HDF 3 mm.  
Decors from the company cartel.  
Made in Bulgaria.

*Single bookcases 40x37/H154cm. and cupboards 40x39/H154cm.*



Code: 140 135400



Code: 140 131400



Code: 140 131412



Code: 140 131413



Code: 140 131414

*Single bookcases 40x37/H190cm. and cupboards 40x39/H190cm.*



Code: 140 135500



Code: 140 131500



Code: 140 131512



Code: 140 131513



Code: 140 131518



Code: 140 131515

*Double office cupboards and bookcases*

*Double office cupboards and bookcases H81cm.*



Code: 140 132200



Code: 140 132212

*Triple cupboard for office equipment*



Code: 140 133212

*Double office cupboards and bookcases H117cm.*



Code: 140 132300



Code: 140 132312



Code: 140 132313

Modular furniture with various levels.  
 Space between shelves 34 cm.  
 Body and shelves of 18mm chipboard.  
 Doors with quality hinges.  
 Option for placing locks.  
 Back of laminated HDF 3 mm.  
 Decors from the company cartel.  
 Made in Bulgaria.

*Double bookcases 80x37/H154cm. and cupboards 80x39/H154cm.*



Code: 140 132400



Code: 140 132412



Code: 140 132413



Code: 140 132414

*Double bookcases 80x37/H190cm. and cupboards 80x39/H190cm.*



Code: 140 132500



Code: 140 132512



Code: 140 132513



Code: 140 132518



Code: 140 132515

Manager chairs



**Chair Boss ECO**  
Article No Upholstery  
411 F10024 ECO-30, ECO-21



**Chair Diplomat**  
Article No Upholstery  
411 F10010 C-11, C-38



**Chair Elly Tilt**  
Article No Upholstery  
411 F10040 ECO-30



**Chair Factor**  
Article No Upholstery  
411 F11015 SP-A, ECO-21



**Chair Florida**  
Article No Upholstery  
411 F10020 ECO-30, ECO-07



**Chair King**  
Article No Upholstery  
411 F10065 ECO-07, ECO-30



**Chair Liberty**  
Article No Upholstery  
411 F10060 ECO-30



**Chair Faraon**  
Article No Upholstery  
411 F10030 ECO-30, ECO-90



**Chair Manager steel**  
Article No Upholstery  
411 F10055 SP-01



**Chair Morfeo**  
Article No Upholstery  
411 F10045 ECO-30



**Chair Nadir steel**  
Article No Upholstery  
411 F10070 V-04-18, SP-01-02



**Chair Riga steel**  
Article No Upholstery  
411 F10035 ECO-30, ECO-07



**Chair Venta**  
**Article Np**      **Upholstery**  
 411 F10050      ECO-70, ECO-30



**Chair Pegaz steel**  
**Article No**      **Upholstery**  
 411 F20025      C-11, 14, 29, 38



**Chair Pegaso GTP**  
**Article No**      **Upholstery**  
 411 F20015      C-11, C-38



**Chair Smart white**  
**Article No**      **Upholstery**  
 411 F20020      YB-097, 156, 130

*Work chairs*



**Chair Forex GTP**  
**Article No**      **Upholstery**  
 411 F20005      C-11, 14, 16, 38



**Chair Prestige GTP**  
**Article No**      **Upholstery**  
 411 F20010      C-11, 14, 29, 38



**Chair Prestige C-U**  
**Article No**      **Upholstery**  
 411 F20012      C-11, 14, 29, 38



**Chair Iso black**  
**Article No**      **Upholstery**  
 411 F30005      C-11, 14, 29, 38

*Visitor chairs*



**Chair Rumba chrome**  
**Article No**      **Upholstery**  
 411 F30030      V-18, V-04



**Chair Samba**  
**Article No**      **Upholstery**  
 411 F30020      V-18, V04



**Chair Era chrome**  
**Article No**      **Upholstery**  
 411 F30025      C-11, 14, 38



**Chair Ascona chrome**  
**Article No**      **Upholstery**  
 411 F30020      Black





## Racking system SMART 40

SMART 40 is a flexible solution for arranging and storing, fits well in the office, library and classroom.

We offer SMART 40 in various installation systems for wall, freestanding, double-sided and movable shelves. Constructive solutions guaranteeing strength and security.

Metal construction of rectangular profile 50x30mm. Easy installation and quick rearrangement of the shelves.

Adjustable plastic steps with metal thread.

Shelves made of 1.5 mm steel sheet and 18 mm chipboard. Widths of 25, 30 and 40 cm. Lengths of 60, 80 and 90 cm.

Various 1.5 mm sheet metal support brackets.

Height adjustment of the shelves with a step of 4 cm.

Decors of laminated chipboard from the company cartel.

Polymer, powder coating in RAL colors.

Made in Bulgaria.

### Regals SMART 40 with metal shelves 30 cm. and high sides

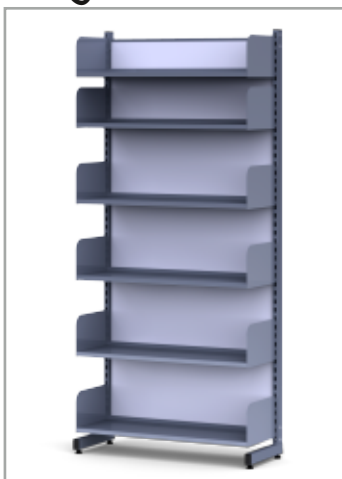

**Article No**  
170 A69304  
**Shelves**

**Size**  
93x35H200cm  
90x30H19,5cm

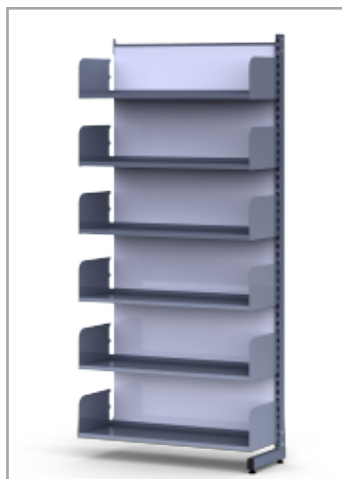

**Article No**  
170 A69305  
**Shelves**

**Size**  
91x35H200cm  
90x30H19,5cm

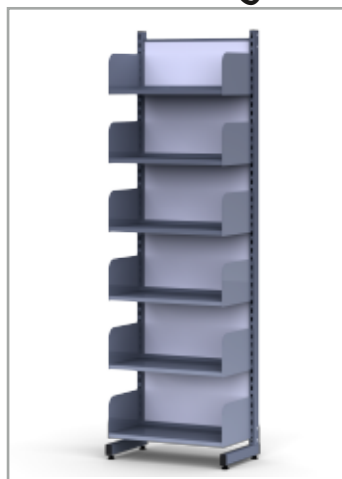

**Article No**  
170 A66304  
**Shelves**

**Size**  
63x35H200cm  
60x30H19,5cm

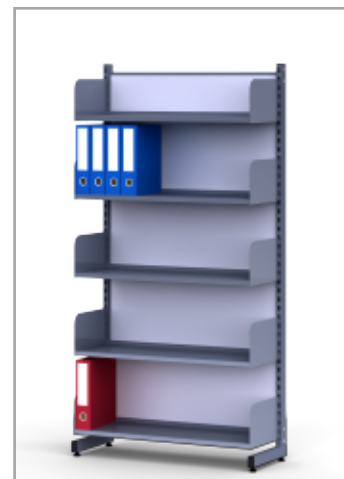

**Article No**  
170 A59384  
**Shelves**

**Size**  
93x35H180cm  
90x30H19,5cm

### Regals SMART 40 with metal shelves 30 cm. and low sides



**Article No**  
170 D69304  
**Shelves**

**Size**  
93x35H200cm  
90x30H13,5cm

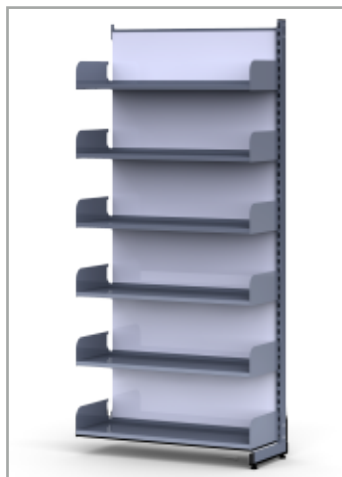

**Article No**  
170 D69305  
**Shelves**

**Size**  
91x35H200cm  
90x30H13,5cm

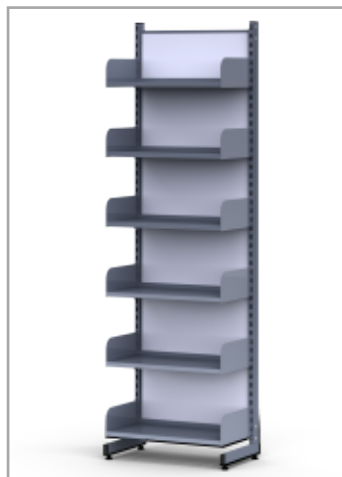

**Article No**  
170 D66304  
**Shelves**

**Size**  
63x35H200cm  
60x30H13,5cm

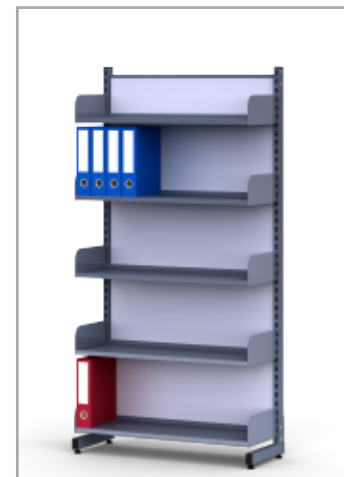

**Article No**  
170 D59384  
**Shelves**

**Size**  
93x35H180cm  
90x30H13,5cm

*Mobile regals SMART 40 with metal or chipboard shelves 30cm.*



**Article No**  
170 G49364  
**Shelves**

**Size**  
93x65H160cm  
90x30H19,5cm



**Article No**  
170 H59364  
**Shelves**

**Size**  
93x65H160cm  
90x30H13,5cm



**Article No**  
170 H49262  
**Shelves**

**Size**  
93x65H160cm  
90x30H13,5cm



**Article No**  
170 449364  
**Shelves**

**Size**  
93x65H160cm  
90x30H1,8cm

*Two-sided regals SMART 40 with metal shelves 30 cm.*



**Article No**  
170 B69304  
**Shelves**

**Size**  
93x65H200cm  
90x30H19,5cm

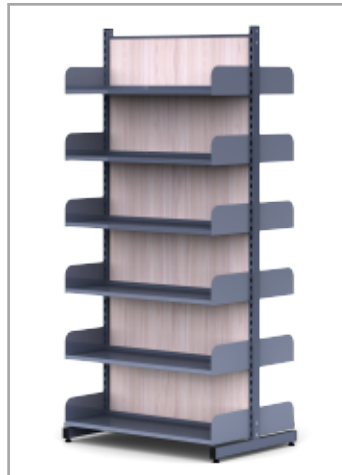

**Article No**  
170 E69304  
**Shelves**

**Size**  
93x65H200cm  
90x30H13,5cm

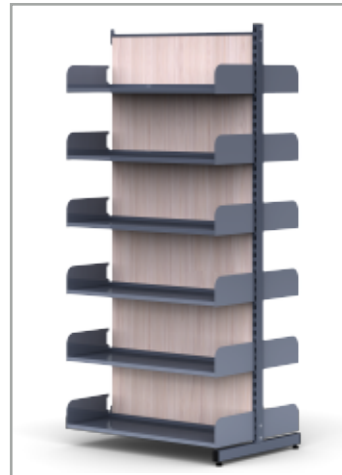

**Article No**  
170 E69305  
**Shelves**

**Size**  
91x65H200cm  
60x30H13,5cm

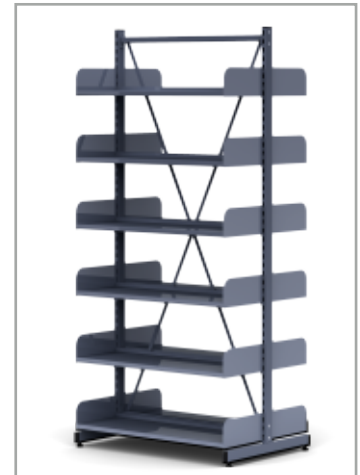

**Article No**  
170 E69302  
**Shelves**

**Size**  
93x65H200cm  
90x30H13,5cm

*One-sided and two-sided regals SMART 40 with chipboard shelves 30 cm.*



**Article No**  
170 169304  
**Shelves**

**Size**  
93x35H200cm  
90x30H1,8cm



**Article No**  
170 169305  
**Shelves**

**Size**  
91x35H200cm  
90x30H1,8cm



**Article No**  
170 269304  
**Shelves**

**Size**  
93x65H200cm  
60x30H1,8cm



**Article No**  
170 269305  
**Shelves**

**Size**  
91x65H200cm  
90x30H1,8cm

## Perforated legs for regals SMART 40

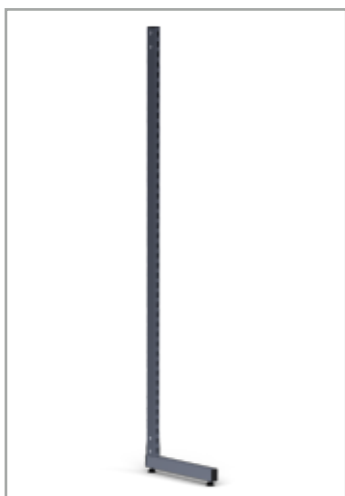

**L-leg for one-sided regals SMART 40**

Article No	Size
171 202716	3x27 H160cm
171 202718	3x27 H180cm
171 202720	3x27 H200cm
171 203216	3x32 H160cm
171 203218	3x32 H180cm
171 203220	3x32 H200cm
171 204216	3x42 H160cm
171 204218	3x42 H180cm
171 204220	3x42 H200cm



**T-leg for two-sided regals SMART 40**

Article No	Size
171 305016	3x49 H160cm
171 305018	3x49 H180cm
171 305020	3x49 H200cm
171 306016	3x59 H160cm
171 306018	3x59 H180cm
171 306020	3x59 H200cm
171 308016	3x79 H160cm
171 308018	3x79 H180cm
171 308020	3x79 H200cm

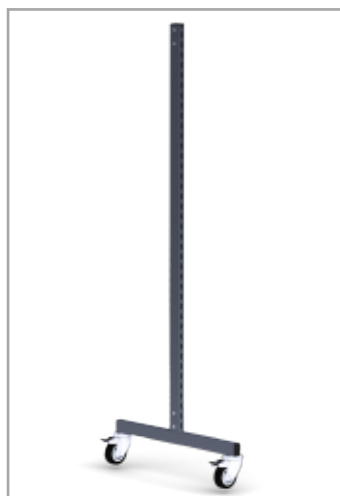

**T-leg for mobile regals SMART 40**

Article No	Size
171 315014	3x49 H140cm
171 315016	3x49 H160cm
171 315018	3x49 H180cm
171 316014	3x59 H140cm
171 316016	3x59 H160cm
171 316018	3x59 H180cm
171 318014	3x79 H140cm
171 318016	3x79 H160cm
171 318018	3x79 H180cm

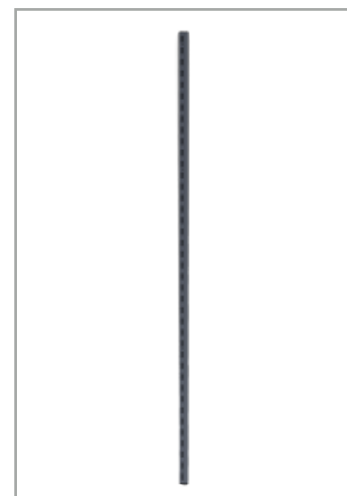

**Wall profile 30x20mm for regals SMART 40**

Article No	Size
171 100012	3x2 H120cm
171 100014	3x2 H140cm
171 100016	3x2 H160cm
171 100018	3x2 H180cm
171 100020	3x2 H200cm

Holes for wall mounting with a diameter of 5,5 mm

## Crossbars, reinforcing elements and backs for regals SMART 40



**Crossbar set for regals SMART 40 without back**

Article No	Size
174 01K060	3x5 L57cm
174 01K080	3x5 L77cm
174 01K090	3x5 L87cm

Supplied with fasteners

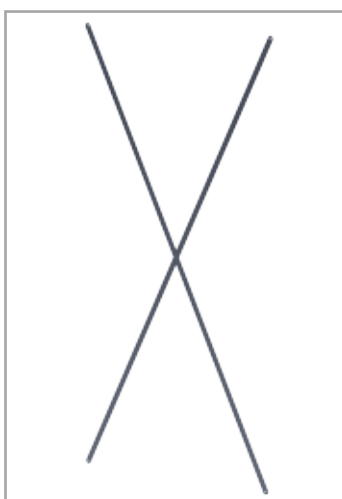

**Set of diagonals for regals SMART 40**

Article No	Size
174 91K614	60cm H140cm
174 91K616	60cm H160cm
174 91K618	60cm H180cm
174 91K620	60cm H200cm
174 91K914	90cm H140cm
174 91K916	90cm H160cm
174 91K918	90cm H180cm
174 91K920	90cm H200cm



**Laminated chipboard back for regals SMART 40**

Article No	For size
174 920614	60cm H140cm
174 920616	60cm H160cm
174 920618	60cm H180cm
174 920620	60cm H200cm
174 920914	90cm H140cm
174 920916	90cm H160cm
174 920918	90cm H180cm
174 920920	90cm H200cm



**Crossbar set for regals SMART 40 with back**

Article No	Size
174 02K060	3x2 L57cm
174 02K080	3x2 L77cm
174 02K090	3x2 L87cm

Supplied with fasteners

Organize your workplace with the SMART 40 system



*Metal and laminated chipboard shelves for regals SMART 40*

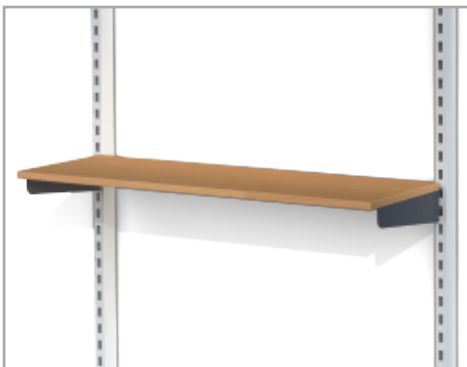

**Laminated chipboard shelf  
for regals SMART 40**  
Load capacity up to 30 kg.

Article No	Size
172 716025	60x25 H9cm
172 716030	60x30 H9cm
172 716040	60x40 H9cm
172 718025	80x25 H9cm
172 718030	80x30 H9cm
172 718040	80x40 H9cm
172 719025	90x25 H9cm
172 719030	90x30 H9cm
172 719040	90x40 H9cm

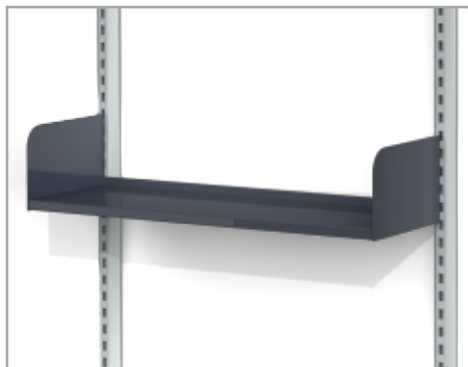

**Metal shelf with high sides  
for regals SMART 40**  
Load capacity up to 70 kg.

Article No	Size
172 136025	60x25 H19,5cm
172 136030	60x30 H19,5cm
172 136040	60x40 H19,5cm
172 138025	80x25 H19,5cm
172 138030	80x30 H19,5cm
172 138040	80x40 H19,5cm
172 139025	90x25 H19,5cm
172 139030	90x30 H19,5cm
172 139040	90x40 H19,5cm

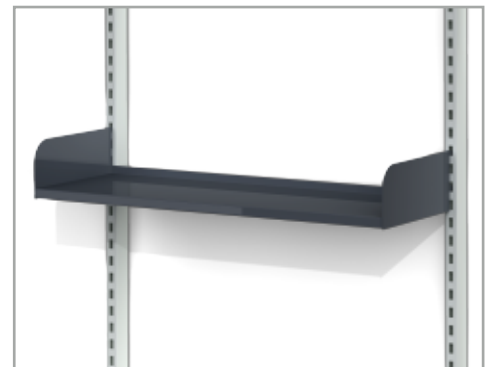

**Metal shelf with high sides  
for regals SMART 40**  
Load capacity up to 60 kg.

Article No	Size
172 116025	60x25 H13,5cm
172 116030	60x30 H13,5cm
172 116040	60x40 H13,5cm
172 118025	80x25 H13,5cm
172 118030	80x30 H13,5cm
172 118040	80x40 H13,5cm
172 119025	90x25 H13,5cm
172 119030	90x30 H13,5cm
172 119040	90x40 H13,5cm

## Seats and backrests

Seats and backs made of formed plywood.  
Material beech with water-based eco varnish.  
Made in Bulgaria.



**Plywood seat 7mm**

Article No	Size
230 804041	40x41/6cm
230 803636	36x36/5cm
230 802828	28x28/3cm



**Plywood backrest 7mm**

Article No	Size
230 904018	40x18/6cm
230 903617	36x17/4cm
230 902814	28x14/3cm

## Glides and steps for furniture



**Round plug**  
260 010025  
260 010028

**Profile**  
Ø25mm  
Ø28mm



**Round glide**  
260 020025  
260 020028

**Profile**  
Ø25mm  
Ø28mm



**Hemispherical glide**  
260 021021

**Profile**  
Ø21,3mm



**Round glide**  
260 020040

**Profile**  
Ø40mm



**Square glide**  
260 112020  
260 113030

**Profile**  
20x20mm  
30x30mm



**Rectangular glide**  
260 213020  
260 214020

**Profile**  
30x20mm  
40x20mm

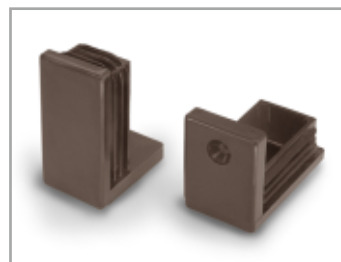

**Rectangular step**  
260 273020  
260 274020

**Profile**  
30x20mm  
40x20mm



**Glide cap**  
260 030025

**Profile**  
Ø25mm



**Flat oval step**  
260 333015  
260 334020

**Profile**  
30x15mm  
40x20mm



**Flat oval plug**  
260 313015  
260 314020

**Profile**  
30x15mm  
40x20mm



**Round step**  
260 052025  
260 052032

**Profile**  
Ø25mm  
Ø32mm



**Console glide**  
260 051025

**Profile**  
Ø25mm



### Round tabletop

Article No	Size
128 600060	D60/1,8cm
128 600070	D70/1,8cm
128 600080	D80/1,8cm
128 600090	D90/1,8cm
128 600120	D120/1,8cm

## Tabletops

Tabletops made of laminated chipboard 18mm.  
Edge 2,00mm with polyolefin glue.  
Decors of chipboard from the company cartel.  
Made in Bulgaria.

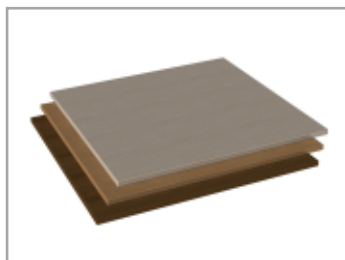

### Square tabletops

Article No	Size
128 006060	60x60/1,8cm
128 007070	70x70/1,8cm
128 008080	80x80/1,8cm
128 009090	90x90/1,8cm

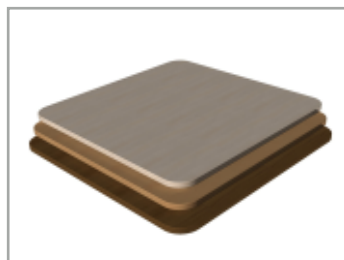

### Tabletop with rounded corners

Article No	Size
128 106060	60x60/1,8cm
128 107070	70x70/1,8cm
128 108080	80x80/1,8cm
128 109090	90x90/1,8cm

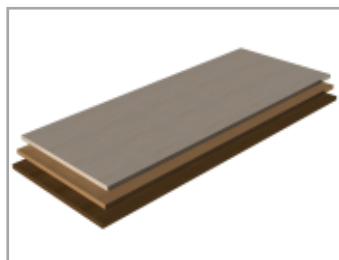

### Rectangular tabletop

Article No	Size
128 006044	60x44/1,8cm
128 007050	70x50/1,8cm
128 012044	120x44/1,8cm
128 012050	120x50/1,8cm

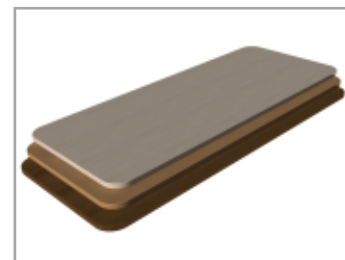

### Tabletop with rounded corners

Article No	Size
128 106044	60x44/1,8cm
128 107050	70x50/1,8cm
128 112044	120x44/1,8cm
128 112050	120x50/1,8cm



### Trapezoidal tabletop

Article No	Size
128 512052	120x52/1,8cm



### Tabletop with rounded corners

Article No	Size
128 612058	120x58/1,8cm

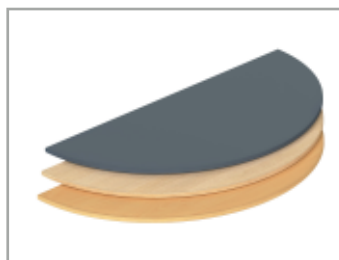

### Semicircle tabletop

Article No	Size
128 312060	120x60/1,8cm

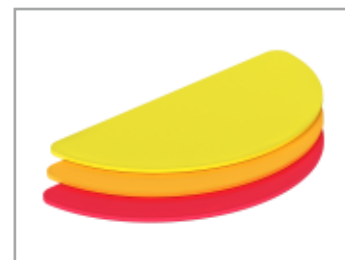

### Tabletop with rounded corners

Article No	Size
128 412060	120x60/1,8cm

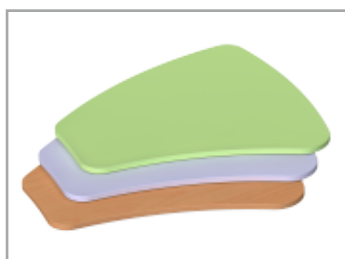

### Tabletop for table POLLY

Article No	Size
128 796000	76x69/1,8cm



### Tabletop for table WAVE

Article No	Size
128 795000	76x60/1,8cm

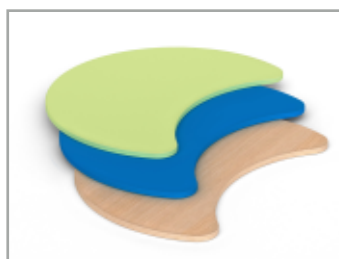

### Tabletop for table MARGARITA

Article No	Size
128 793000	80x59/1,8cm

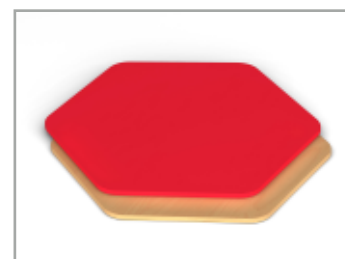

### Hexagonal tabletop

Article No	Size
128 795000	93x83/1,8cm



### Tabletop for table DETELINA

Article No	Size
128 791000	70x47/1,8cm

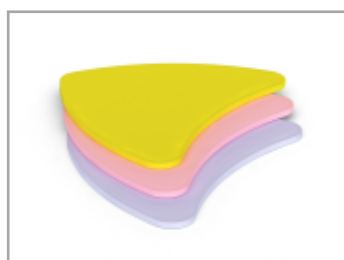

### Tabletop for table FLOWER

Article No	Size
128 792000	69x56/1,8cm



### Front for school table

Article No	Size
128 905022	50x22/1,8cm
128 906022	60x22/1,8cm
128 910022	100x22/1,8cm
128 911022	110x22/1,8cm



### Shelf for school table

Article No	Size
128 805026	50x26/1,8cm
128 805626	56x26/1,8cm
128 810026	100x26/1,8cm
128 810626	106x26/1,8cm

*Colours for metal frames according to the RAL system*



*Colours for laminated boards*

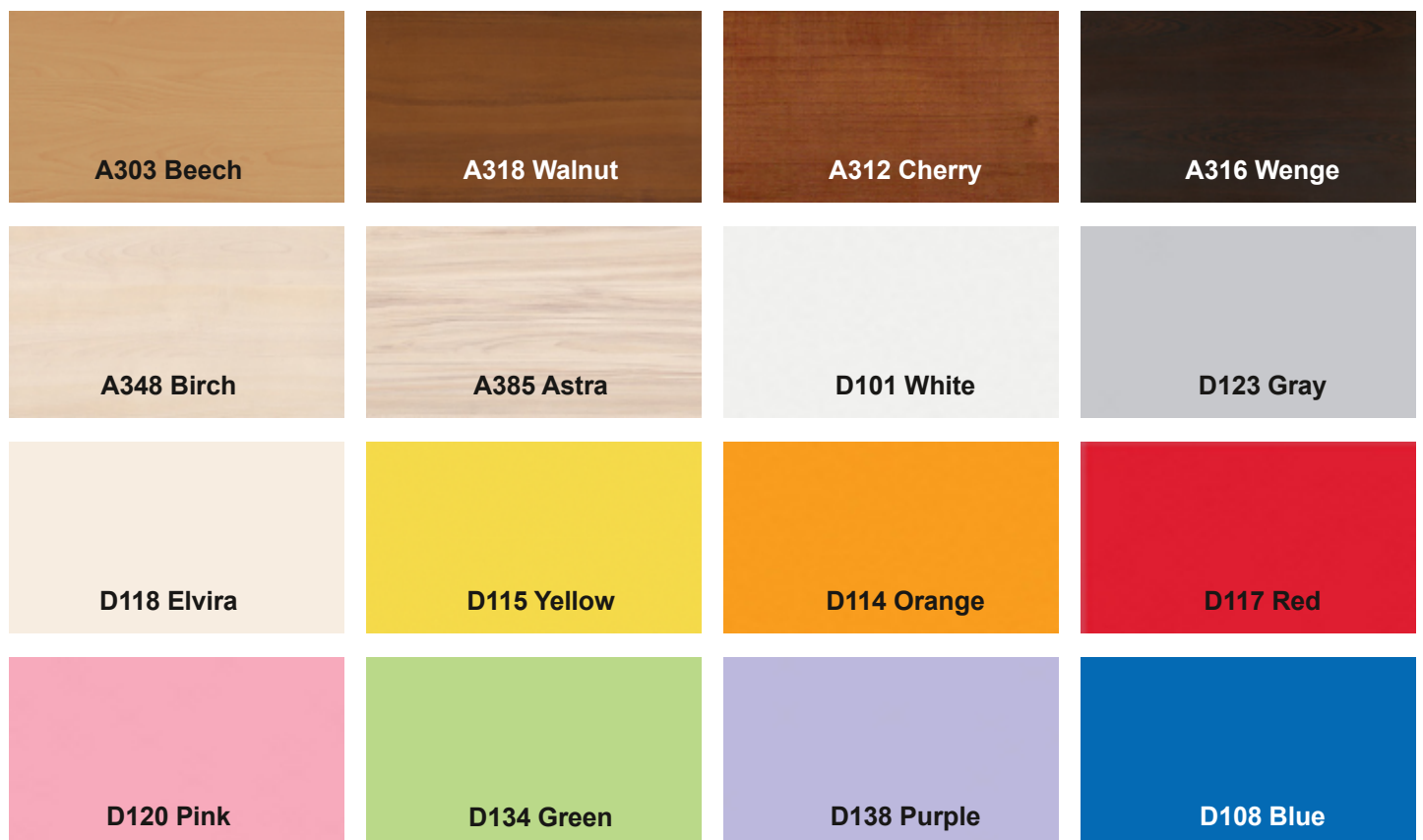

### Colours for synthetic leather for upholstering

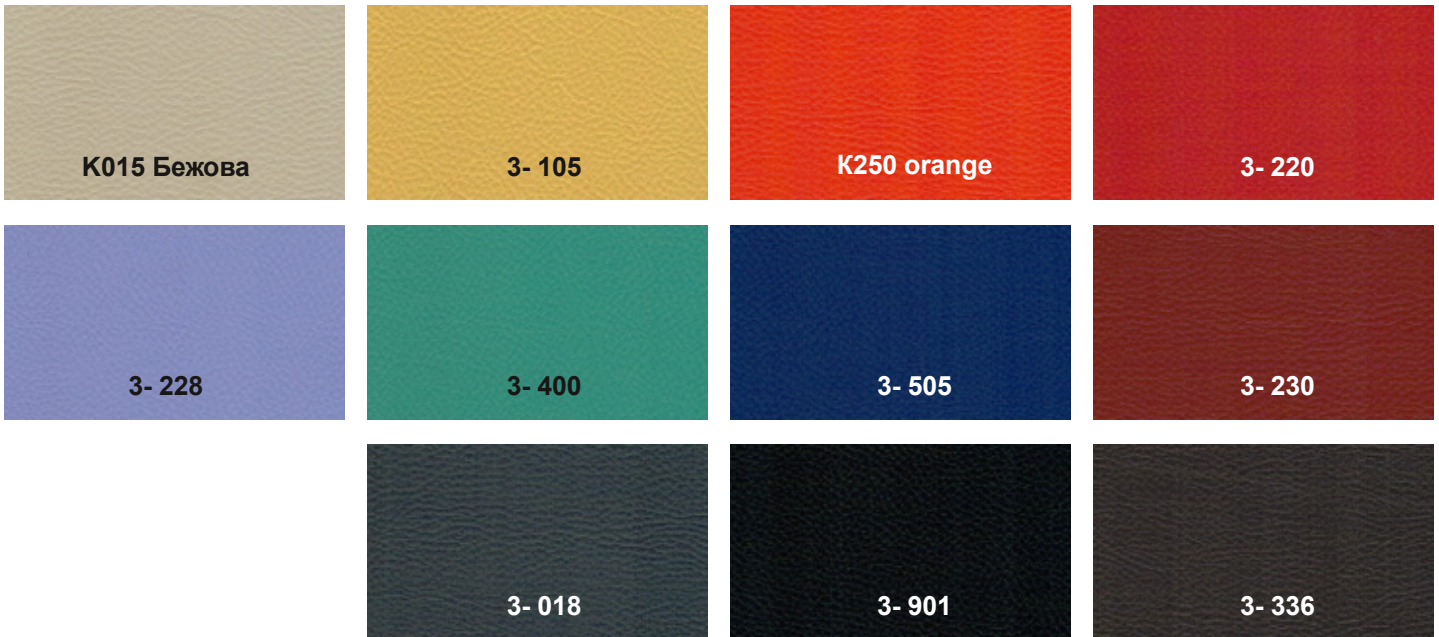

### Colours for fabric

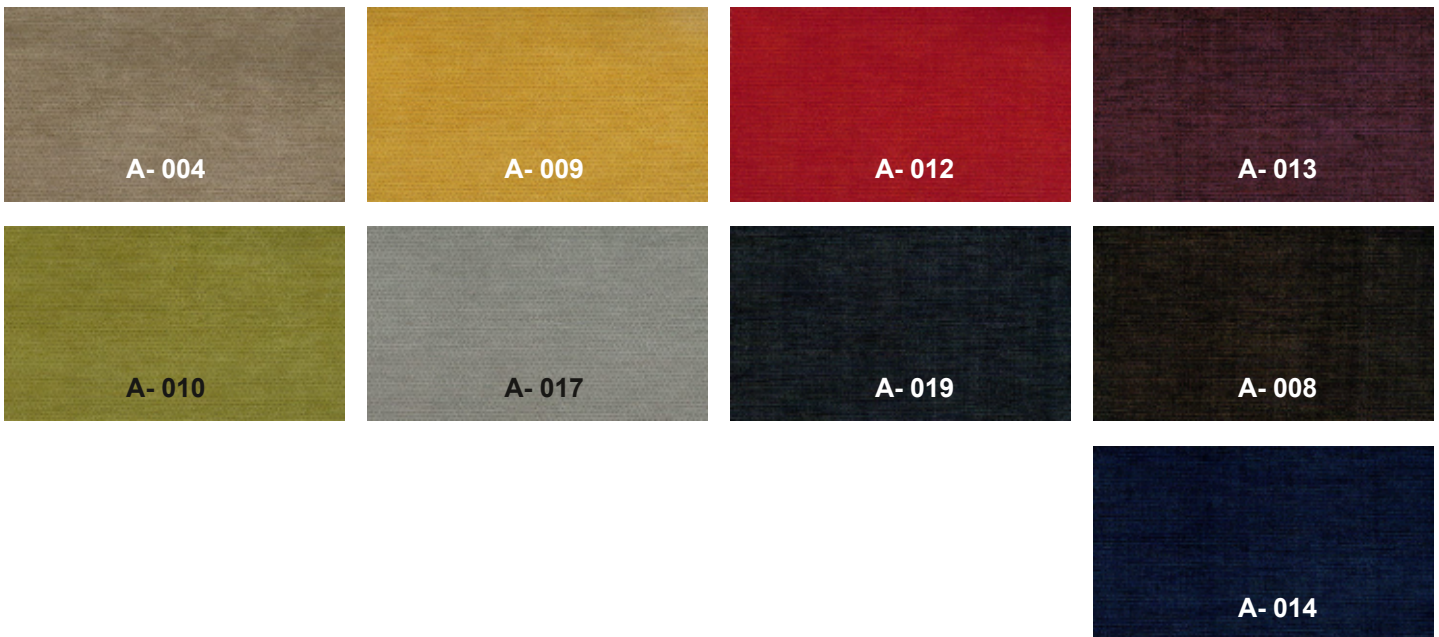

### Colours for ERGO monoblock





## Materials / Fabrics and synthetic leather for office chairs

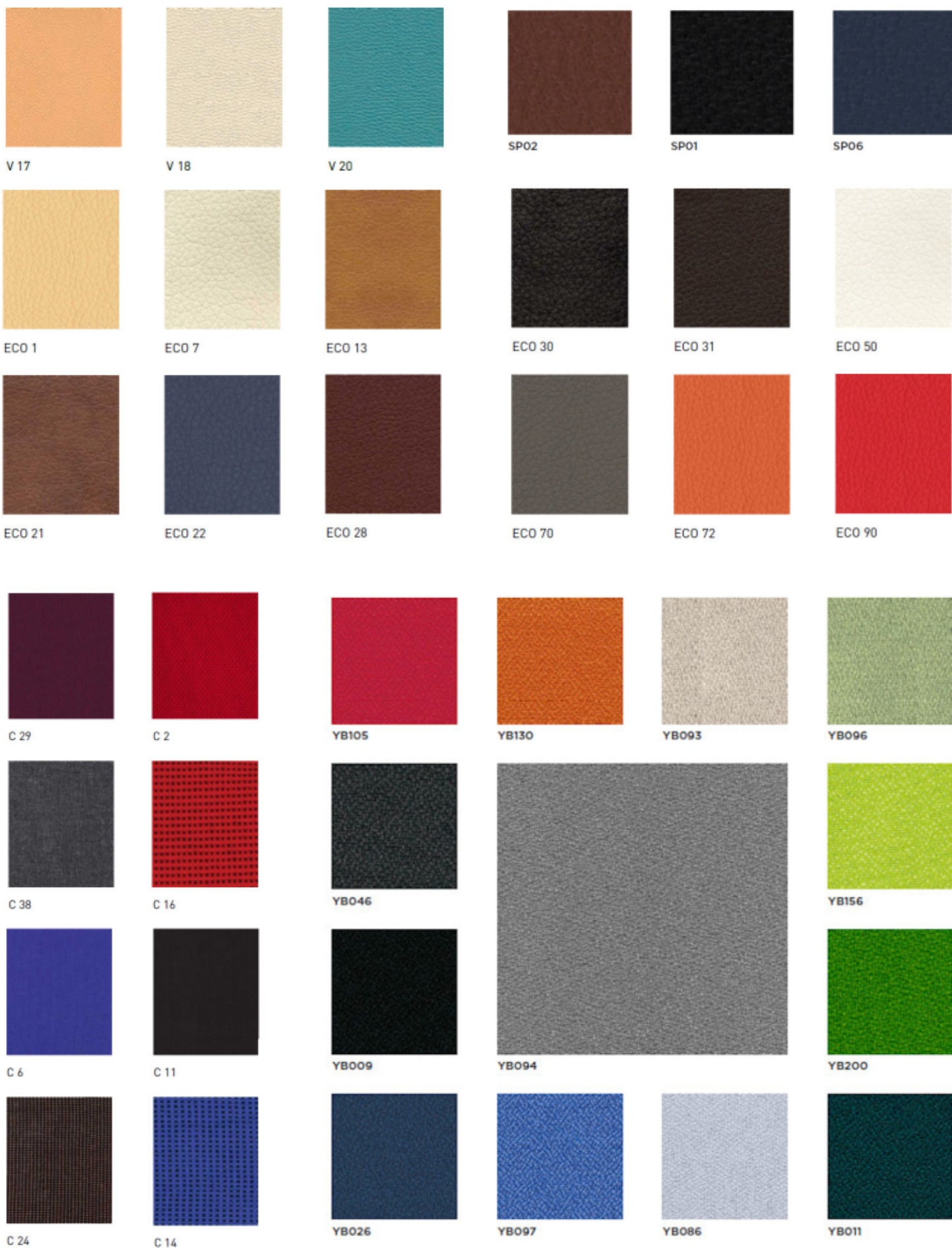

## Together with Mebel Factor®

Designing a classroom according to the vision for the learning process is a challenge. A fundamental change in the world is making the 21st century classroom different from all previous solutions. The change comes from the widespread adoption of collaborative learning programs in an active environment. 21st century classrooms need to support them, because this will be the dominant model of education for the foreseeable future. Let's discuss your ideas together, evaluate and improve at the design stage.



---

---

---

---

---

---

---

---

---

---

---

---

---

---

---

---

---

---

---

---

---

---

---

---